

General Specifications

Electrical Capacity (Resistive Load)

Power Level (silver): 3A @ 125V AC or 3A @ 250V AC or 3A @ 30V DC
Logic Level (gold): 0.4VA maximum @ 28V AC/DC maximum
 (Applicable Range 0.1mA ~ 0.1A @ 20mV ~ 28V)
 Note: Find additional explanation of operating range in Supplement section.

Other Ratings

Contact Resistance: 50 milliohms maximum for silver; 100 milliohms maximum for gold
Insulation Resistance: 200 megohms minimum @ 500V DC
Dielectric Strength: 1,000V AC minimum between contacts for 1 minute minimum;
 1,500V AC minimum between contacts & case for 1 minute minimum
Mechanical Life: 1,000,000 operations minimum for momentary circuit
 200,000 operations minimum for maintained circuit
Electrical Life: 100,000 operations minimum
Nominal Operating Force: 4.41N
Contact Timing: Nonshorting (break-before-make)
Travel: Pretravel .059" (1.5mm); Overtravel .059" (1.5mm); Total Travel .118" (3.0mm)

Materials & Finishes

Housing: Glass fiber reinforced polyamide (UL94V-0)
Snap-in Frame: Stainless steel
Movable Contact: Silver alloy or copper with gold plating
Stationary Contacts: Silver alloy or copper with gold plating
Base: Liquid crystal polymer (UL94V-0)
Switch Terminals: Phosphor bronze with silver or gold plating
Lamp Terminals: Brass with silver plating

Environmental Data

Operating Temperature Range: -25°C through +50°C (-13°F through +122°F) for Illuminated
 -25°C through +70°C (-13°F through +158°F) for Nonilluminated
 Note: When used with a polyvinyl chloride splash cover, the lowest limit is 0°C (32°F)
Humidity: 90 ~ 95% humidity for 96 hours @ 40°C (104°F)
Vibration: 10 ~ 55Hz with peak-to-peak amplitude of 1.5mm traversing the frequency range & returning in 1 minute; 3 right angled directions for 2 hours
Shock: 50G (490m/s²) acceleration (tested in 6 right angled directions, with 5 shocks in each direction)
Sealing: Not available for snap-in; see next section for panel seal.

Installation

Cap Installation Force: 3.92N maximum downward force on cap
Quick Connect Force: 52.95N maximum downward force on connector
Soldering Time & Temperature: Manual Soldering: See Profile A in Supplement section.

Standards & Certifications

Flammability Standards: UL94V-0 housing & base
UL: **File No. E44145 - Recognized only when ordered with marking on switch.**
 Add "/U" or "/CUL" before first dash in part number to order UL recognized switch.
 All models recognized at 3A @ 125V or 250V AC or 0.4VA @ 28V AC/DC maximum.
CSA: **File No. 023535_0_000 - Certified only when ordered with marking on switch.**
 Add "/C" before first dash in part number to order CSA certified switch.
 All models certified at 3A @ 125V or 250V AC or 0.4VA @ 28V AC/DC maximum.

Distinctive Characteristics

Carefully designed light diffusion and filtering system produces bright, full surface illumination with front panel relamping.

Spot illumination available in single and bicolor LEDs.

Choice of super bright LEDs in white, green, and blue in addition to standard or bright red, amber, and green LEDs.

Stainless steel clips provide secure mounting with a wide range of panel thicknesses.

Latchdown feature gives indication of circuit status. Audible and tactile feedback with smooth and responsive operation.

Snap-action contact mechanism gives long electrical life and sensitivity of actuation.

Combination solder lug and .110" quick connect terminals are epoxy sealed to prevent entry of flux, dust, and other contaminants.

Panel sealed model meets IP65 of IEC60529 specifications (similar to NEMA 4 & 13).

Compact switch design minimizes behind panel depth.

Matching indicators available.

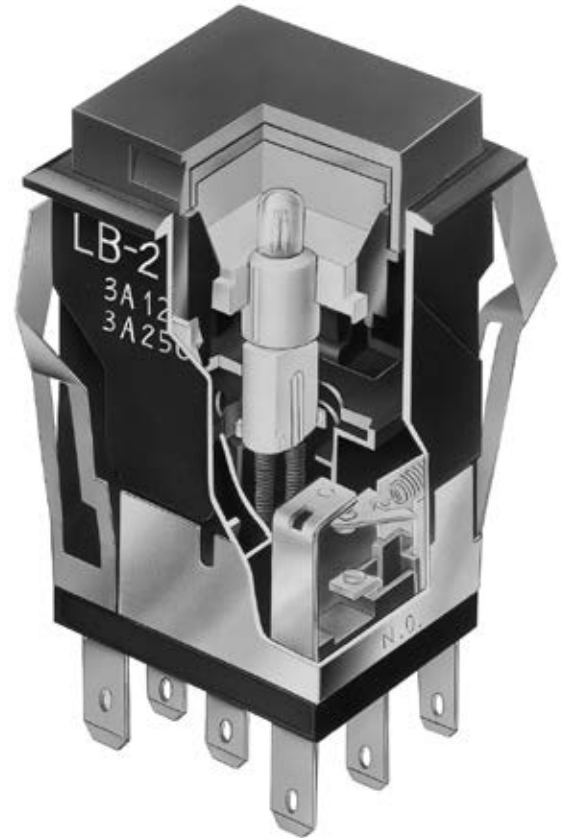

Actual Size

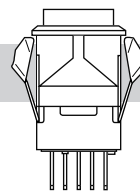
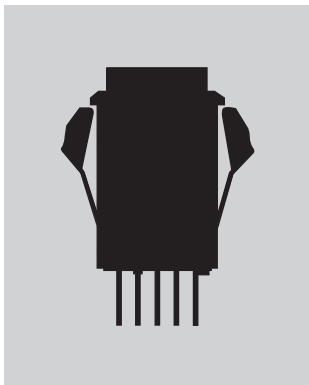

Snap-in Mount Page D48

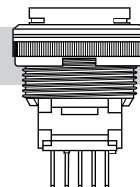

Panel Seal Page D59

- Toggle
- Rockers
- Pushbuttons
- D** Illuminated PB
- Programmable
- Keylocks
- Rotaries
- Slides
- Tactiles
- Tilt
- Touch
- Indicators
- Accessories
- Supplement

TYPICAL SWITCH

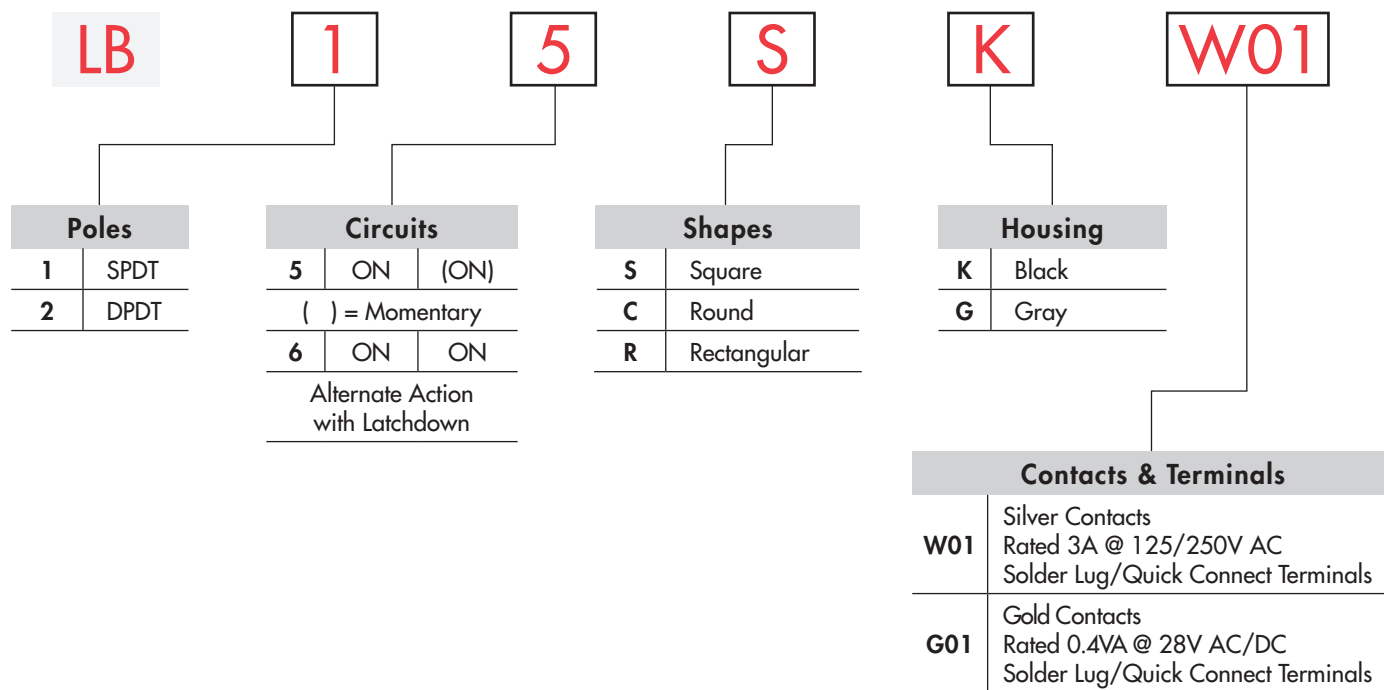

IMPORTANT:



Switches are supplied without UL, cULus and CSA marking unless specified.
UL, cULus & CSA recognized only when ordered with marking on the switch.
 Specific models, ratings, and ordering instructions are noted on the General Specifications page.

DESCRIPTION FOR TYPICAL ORDERING EXAMPLE

LB15SKW01-5C12-JC

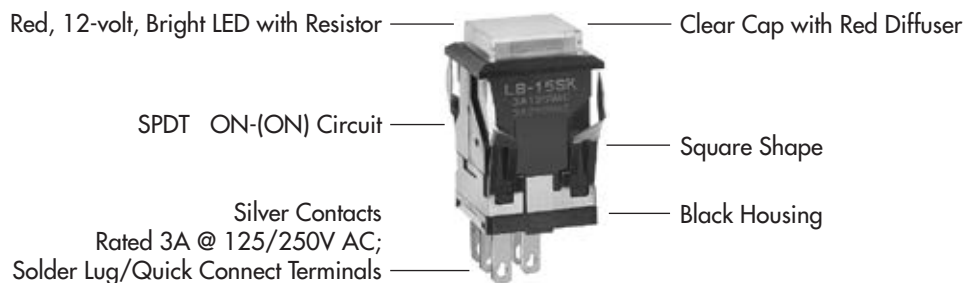

Toggles
Rockers
Pushbuttons
Illuminated PB
Programmable
Keylocks
Rotaries
Slides
Tactiles
Tilt
Touch
Indicators
Accessories
Supplement

ORDERING EXAMPLE

| | | | | | | | |
|--|----------------------|-----------------|-------------|---------------------------------------|--------------|----------|-------|
| 5C 12 | | | | JC | | | |
| Lamps | | | | Cap Types & Colors | | | |
| Incandescent Lamp Used with Solid Cap | | | | Solid Cap: Lens/Filter Colors | | | |
| 05 | 5-volt | | | BJ | White/Clear | | |
| 12 | 12-volt | | | CJ | Red/Clear | | |
| No Code | Nonilluminated | | | EJ | Yellow/Clear | | |
| | | | | FJ | Green/Clear | | |
| | | | | GJ | Blue/Clear | | |
| Incandescent or Neon Used with Insert Cap | | | | Insert Cap: Lens/Filter Colors | | | |
| 01 | 110-volt Neon | | | JB | Clear/White | | |
| 05 | 5-volt Incandescent | | | JC | Clear/Red | | |
| 12 | 12-volt Incandescent | | | JE | Clear/Yellow | | |
| No Code | Nonilluminated | | | *JF | Clear/Green | | |
| | | | | *JG | Clear/Blue | | |
| *JF & JG not suitable with neon. | | | | | | | |
| Bright LED Used with LED Cap | | | | LED Cap: Lens/Diffuser Colors | | | |
| Colors | | Resistor | | JB | Clear/White | | |
| 5C | Red | No Code | No Resistor | JC | Clear/Red | | |
| 5D | Amber | 05 | 5-volt | JD | Clear/Amber | | |
| | | 12 | 12-volt | JF | Clear/Green | | |
| 5F | Green | 24 | 24-volt | | | | |
| Super Bright LED Used with LED Cap | | | | LED Cap: Lens/Diffuser Colors | | | |
| 6B | White | | | JB | Clear/White | | |
| 6F | Green | | | | | | |
| 6G | Blue | | | | | | |
| LED in Spot Illuminated Cap | | | | Spot Illuminated Cap Colors | | | |
| 1C | Red Single Color | | | A | Black | | |
| 1D | Amber Single Color | | | B | White | | |
| 1F | Green Single Color | | | C | Red | | |
| CF | Red/Green Bicolor | | | F | Green | | |
| Available in Square and Round only. | | | | | | | |
| Nonilluminated | | | | Nonilluminated Cap Colors | | | |
| No Code | Nonilluminated | | | A | Black | F | Green |
| | | | | B | White | G | Blue |
| | | | | C | Red | H | Gray |
| | | | | E | Yellow | | |

Toggles

Rockers

Pushbuttons

Illuminated PB

Programmable

Keylocks

Rotaries

Slides

Tactiles

Tilt

Touch

Indicators

Accessories

Supplement

POLES & CIRCUITS

| | | Plunger Position () = Momentary | | Connected Terminals | | Throw & Switch/Lamp Schematics |
|------|---------------|-------------------------------------|------------|---------------------|---------|---|
| Pole | Model | Normal | Down | Normal | Down | Notes: Switch is marked with NC, NO, COM, L+, L-. Lamp circuit is isolated and requires an external power source. |
| SP | LB15 *LB16 | ON ON | (ON) ON | 1-3 | 1-2 | SPDT |
| DP | LB25 *LB26 | ON ON | (ON) ON | 1-3 4-6 | 1-2 4-5 | DPDT |

* When in latchdown position for the alternate circuit, cap position is .039" (1.0mm) above the built-in bezel.

SHAPES & PANEL CUTOUTS

S .622" (15.8mm)
Square

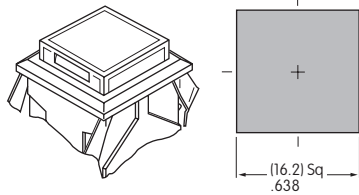

Cutout for 1 switch:
.638" x .638" (16.2mm x 16.2mm)
Cutout for 1 switch with barriers:
.638" x .815" (16.2mm x 20.7mm)

C .854" (21.7mm)
Round

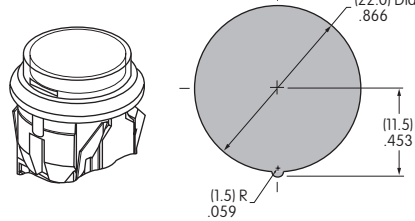

R .622" x .866" (15.8mm x 22.0mm)
Rectangular

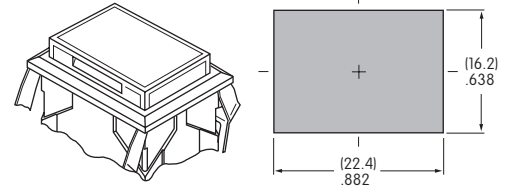

Cutout for 1 switch:
.638" x .882" (16.2mm x 22.4mm)
Cutout for 1 switch with barriers:
.638" x 1.059" (16.2mm x 26.9mm)

Panel Thickness for Switches & Barriers: .039" ~ .157" (1.0 ~ 4.0mm)
Panel Thickness for Protective Guards & Splash Covers: .039" ~ .138" (1.0 ~ 3.5mm)

HOUSING

Housing Colors Available:

K Black

G Gray

CONTACT MATERIALS, RATINGS & TERMINALS

W01

Silver Contacts

Power Level
3A @ 125V AC & 250V AC

G01

Gold Contacts

Logic Level
0.4VA max. @ 28V AC/DC max.

Solder Lug/Quick Connect

Optional PCB adaptors
AT711 & AT712 available;
illustrated in "Optional
Accessories" immediately following
"Typical Switch Dimensions."

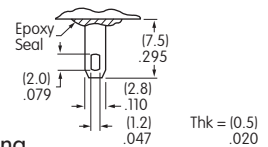

Thk = (0.5) .020

Complete explanation of operating range in Supplement section.

INCANDESCENT & NEON LAMP CODES & SPECIFICATIONS

AT607 & AT607N



T-1 Bi-pin

| | | 05 | 12 | 01 * |
|---------------------|--|---------------|-----------|-------------|
| | AT607 Incandescent 5-volt or 12-volt; AT607N Neon 110-volt | | | |
| Voltage | V | 5V AC | 12V AC | 110V AC |
| Current | I | 115mA | 60mA | 1.5mA |
| Endurance | Avg. Hours | 10,000 | | 10,000 |
| Ambient Temp. Range | | -25°C ~ +50°C | | |



The electrical specifications shown are determined at a basic temperature of 25°C. Lamp circuit is isolated and requires external power source.

* Recommended Resistors for Neon:
33K ohms for 110V AC;
100K ohms for 220V AC

LED COLORS & SPECIFICATIONS

The electrical specifications shown are determined at a basic temperature of 25°C.
 LED circuit is isolated and requires external power source. Polarity marks are on the switch.
 If the source voltage exceeds the rated voltage, a ballast resistor is required.
 The resistor value can be calculated by using the formula in the Supplement section.
 Additional lamp detail is shown in the Accessories & Hardware section.

Bright LED without Resistor

| | | | | | | | | |
|--|-----------------------------------|------------------|--------------------|--------------------|----------------------------|------|-------|-------|
| AT635 LEDs are colored in OFF state.   T-1 1/2 Bi-pin | Color Codes | Red 5C | Amber 5D | Green 5F | No Code No Resistor | Red | Amber | Green |
| | Maximum Forward Current | I_{FM} | | | 30mA | 30mA | 30mA | |
| | Typical Forward Current | I_F | | | 20mA | 20mA | 20mA | |
| | Forward Voltage | V_F | | | 1.9V | 2.0V | 2.1V | |
| | Maximum Reverse Voltage | V_{RM} | | | 5V | 5V | 5V | |
| | Current Reduction Rate Above 25°C | ΔI_F | | | 0.42mA/°C | | | |
| | Ambient Temperature Range | | | | -25° ~ +50°C | | | |

Bright LED with Resistor

| | | | | | | | |
|---|-----------------------------------|------------------|--------------------|--------------------|----------------|------|------|
| AT627 with Resistor  T-1 Bi-pin | Color Codes: | Red 5C | Amber 5D | Green 5F | Resistor Codes | | |
| | | 05 | 12 | 24 | | | |
| | Maximum Forward Current | I_{FM} | | | — | — | — |
| | Typical Forward Current | I_F | | | 52mA | 26mA | 13mA |
| | Forward Voltage | V_F | | | 5V | 12V | 24V |
| | Maximum Reverse Voltage | V_{RM} | | | 4V | 8V | 16V |
| | Current Reduction Rate Above 25°C | ΔI_F | | | 0.50mA/°C | | |
| | Ambient Temperature Range | | | | -25° ~ +50°C | | |

AT627
5-volt
4-element
with Resistor

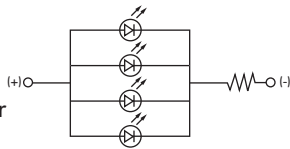

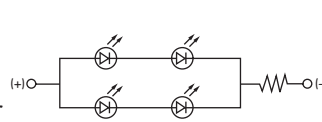

AT627
12-volt
4-element
with Resistor

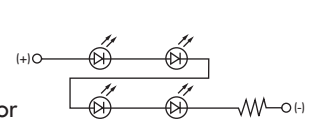

AT627
24-volt
4-element
with Resistor



Super Bright Single Element LED

| | | | | | | | |
|--|---|--------------|-------|-----------|--------------|-----------|-----------|
| AT625G Blue AT631B White AT632F Green   T-1 Bi-pin |  | | | 6B | 6F | 6G | |
| | Color | White | Green | Blue | | | |
| | Maximum Forward Current | I_{FM} | | | 30mA | 30mA | 30mA |
| | Typical Forward Current | I_F | | | 20mA | 20mA | 20mA |
| | Forward Voltage | V_F | | | 3.3V | 3.3V | 3.3V |
| | Maximum Reverse Voltage | V_{RM} | | | 7V | 7V | 7V |
| | Current Reduction Rate Above 25°C | ΔI_F | | | 0.40mA/°C | 0.40mA/°C | 0.40mA/°C |
| | Ambient Temperature Range | | | | -25° ~ +50°C | | |

No Code

No Lamp

CAP TYPES & COLOR COMBINATIONS

Color Codes: B White C Red D Amber E Yellow F Green G Blue J Clear

Solid Cap for Incandescent Lamp & Nonilluminated

Lens/Filter
Colors Available:

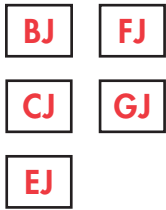

AT476
Square

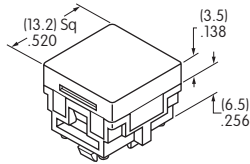

AT4012
Round

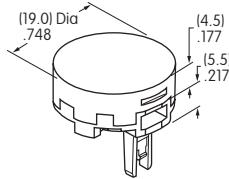

AT4026
Rectangular

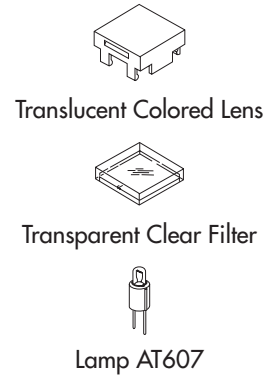
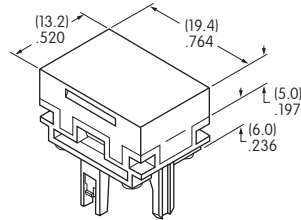

Material: Polycarbonate Finish: Glossy

Insert Cap for Incandescent or Neon Lamp & Nonilluminated

Lens/Filter
Colors Available:

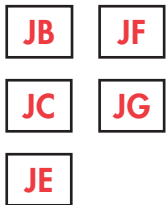

AT477
Square

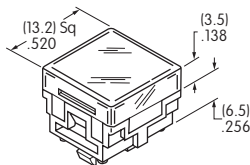

AT4013
Round

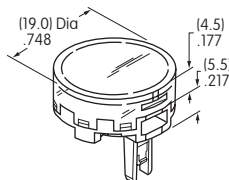

AT4027
Rectangular

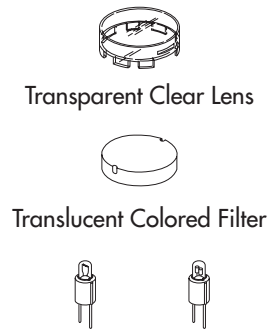
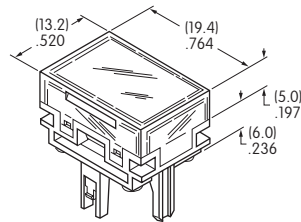

JF and JG not suitable with neon lamp.

Material: Polycarbonate Finish: Glossy

Cap for Bright LED without Resistor

Lens/Diffuser
Colors Available:



AT4176
Square

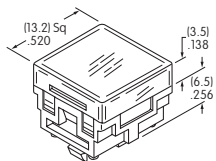

AT4178
Round

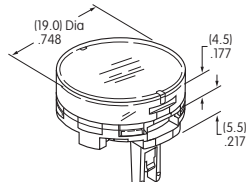

AT4177
Rectangular

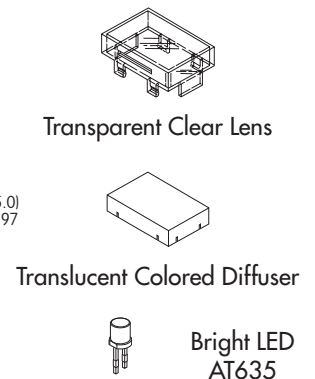
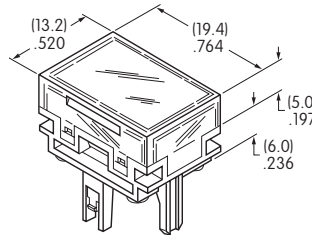

Material: Polycarbonate Finish: Glossy

Cap for Bright LED with Resistor

Lens/Diffuser
Colors Available:



AT4162
Square

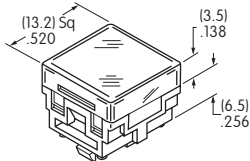

AT4164
Round

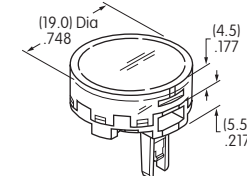

AT4163
Rectangular

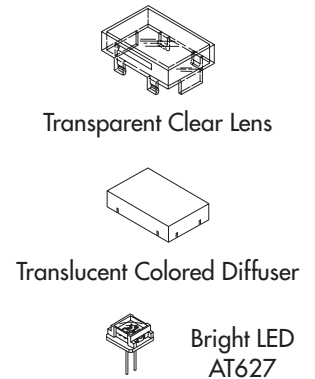
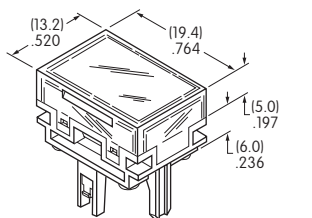

Material: Polycarbonate Finish: Glossy

Toggles
Rocker
Pushbuttons
Illuminated PB
Programmable
Keylocks
Rotaries
Slides
Tactiles
Tilt
Touch
Indicators
Accessories
Supplement

CAP TYPES & COLOR COMBINATIONS

Color Codes: A Black B White C Red D Amber E Yellow F Green G Blue H Gray J Clear

Cap for Super Bright LEDs

JB

Clear Lens
White Diffuser

AT4129
Square

AT4128
Round

AT4130
Rectangular

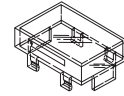

Transparent
Clear Lens

Material:
Polycarbonate
Finish: Glossy

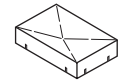
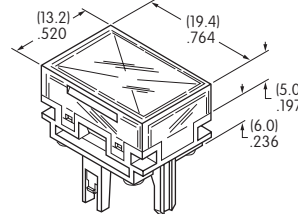
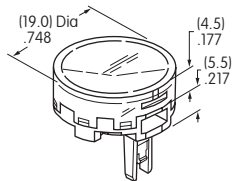
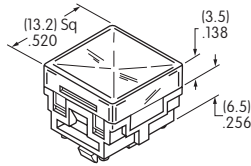

Translucent
White Diffuser



LEDs AT625
AT631 AT632

Spot Illuminated Cap with LED

The electrical specifications shown are determined at a basic temperature of 25°C. LED circuit is isolated and requires an external power source. Single color LEDs are colored in OFF state; bicolor LEDs are translucent white in OFF state. Polarity marks are on the switch. If the source voltage exceeds the rated voltage, a ballast resistor is required. The resistor value can be calculated by using the formula in the Supplement section. Additional lamp detail is shown in the Accessories & Hardware section.

LED Specifications

| LED factory assembled in Spot Illuminated Caps | Single Color LED with 1 Element | Bicolor LED with 2 Elements | Single Color | | | Bicolor |
|--|-------------------------------------|---------------------------------|------------------|--------------------|--------------------|------------------------|
| | | | 1C Red | 1D Amber | 1F Green | CF Red/Green |
| Not Available Separately | Maximum Forward Current | I_{FM} | 25mA | 30mA | 25mA | 30/25mA |
| | Typical Forward Current | I_F | 20mA | 20mA | 20mA | 20mA |
| | Forward Voltage | V_F | 2.25V | 2.1V | 2.2V | 2.0/2.2V |
| | Maximum Reverse Voltage | V_{RM} | 5V | 5V | 5V | — |
| | Current Reduction Rate Above 25°C | ΔI_F | 0.33mA/°C | 0.40mA/°C | 0.33mA/°C | 0.43/0.38mA/°C |
| | Ambient Temperature Range | -25° ~ +70°C | | | | |

Cap Colors Available:

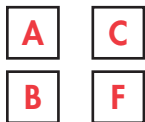

Material:
Polycarbonate
Finish: Glossy

AT480
Square

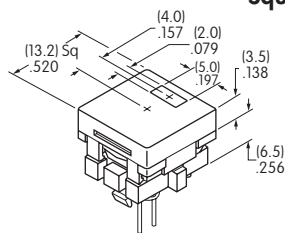

AT4016
Round

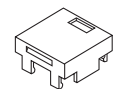
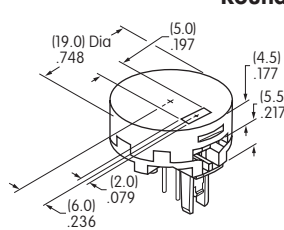

Cap with Window



Factory Assembled LED;
Not Available Separately

When ordering spot illuminated cap separately, LED color must be specified.
Examples: AT480CA (red LED, black cap); AT4016CFB (red/green bicolored LED, white cap)

Cap for Nonilluminated

Cap Colors Available:

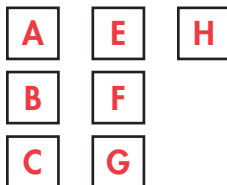

AT484
Square

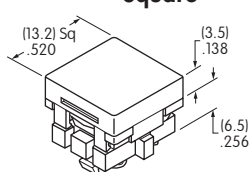

AT4017
Round

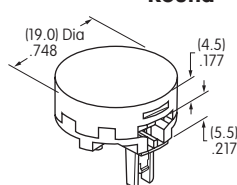

AT4030
Rectangular

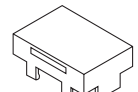
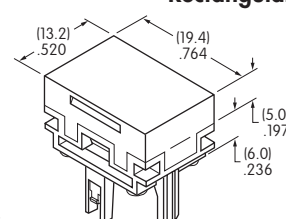

Cap
No Lamp

Material: Polycarbonate Finish: Glossy

TYPICAL SWITCH DIMENSIONS

Square

Single & Double Pole

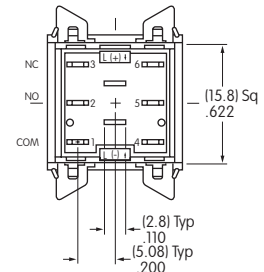
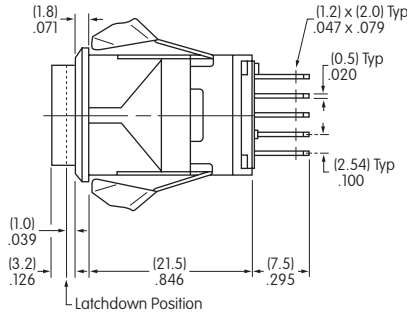
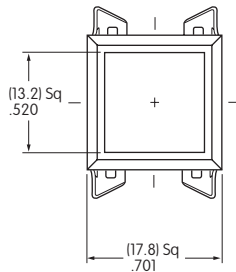

LB15KW01-12-CJ

Single pole models do not have terminals 4, 5, & 6.

Round

Single & Double Pole

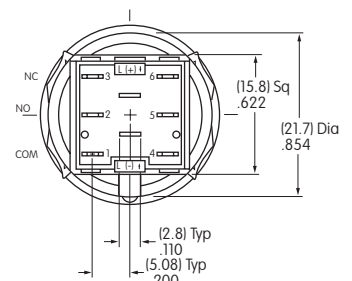
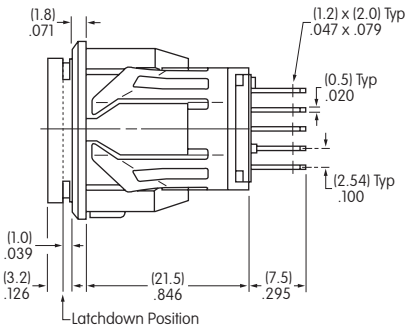
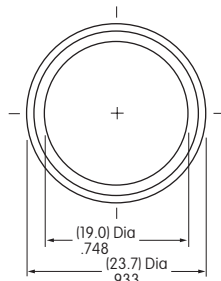

LB16CKW01-12-CJ

Single pole models do not have terminals 4, 5, & 6.

Rectangular

Single & Double Pole

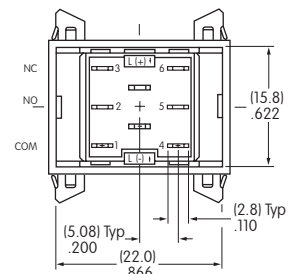
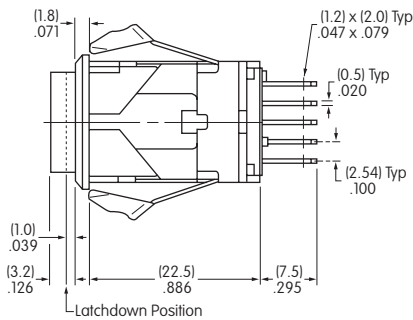
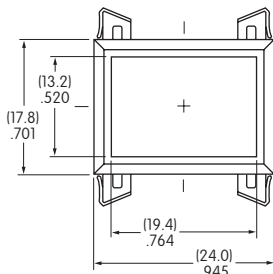

LB26RGW01-12-CJ

Single pole models do not have terminals 4, 5, & 6.

OPTIONAL ACCESSORIES

PCB Adaptors

AT711 Single Pole • Straight PC Terminals

AT712 Double Pole • Straight PC Terminals

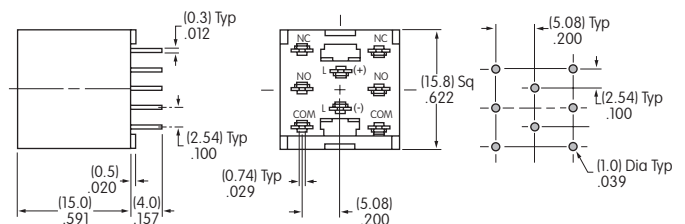
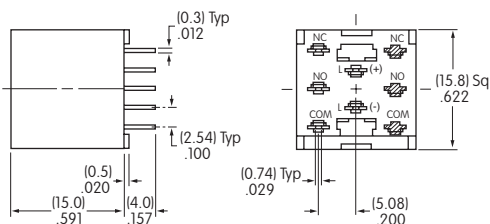

Note: Order adaptors separately.

OPTIONAL ACCESSORIES

Barriers

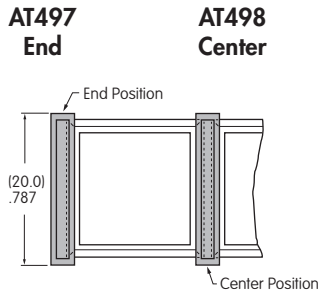

Material: Polyamide

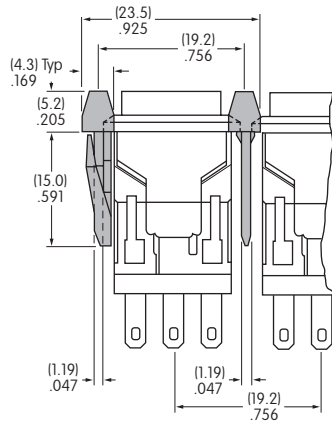

Cutouts for More Than 1 Switch

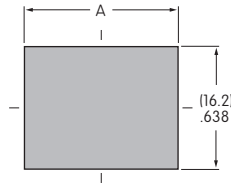

Square
 $A = .752" (19.1\text{mm}) \times \text{Number of Switches} + .051" (1.3\text{mm})$
Rectangular
 $A = .996" (25.3\text{mm}) \times \text{Number of Switches} + .051" (1.3\text{mm})$

Protective Guard

AT499 Square Protective Guard

Opens 90°
Closes manually

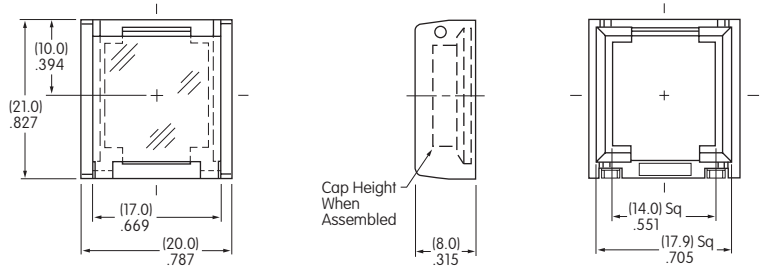

Material: Polyamide

Protective Guards reduce depth of switch behind panel by .020" (0.5mm).

Spring Loaded Protective Guard

AT4171 Square Protective Guard

Opens 180°
Closes automatically

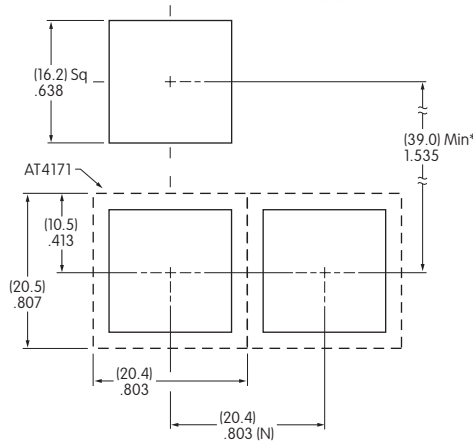
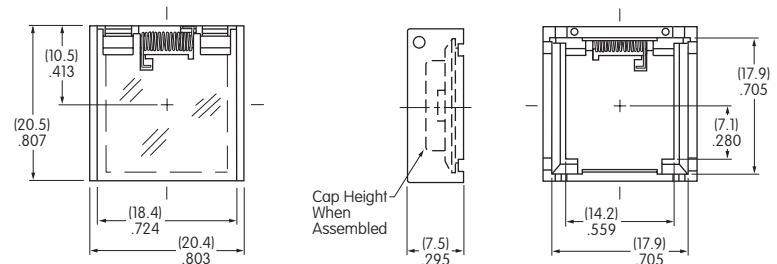

(N) = Number of switches * Minimum dimension allows opening of cover to 180°

Materials:

Cover: Clear Polycarbonate
 Base: Black GFR Polyamide
 Coil Spring: Stainless Steel

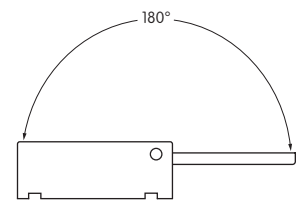

Recommended Panel Thickness:
 .039" ~ .106" (1.0mm ~ 2.7mm)

Toggles
 Rockers
 Pushbuttons
D Illuminated PB
 Programmable
 Keylocks
 Rotaries
 Slides
 Tactiles
 Tilt
 Touch
 Indicators
 Accessories
 Supplement

OPTIONAL ACCESSORIES

AT4057 Rectangular Protective Guard

Opens 90°
Closes manually



Protective Guard

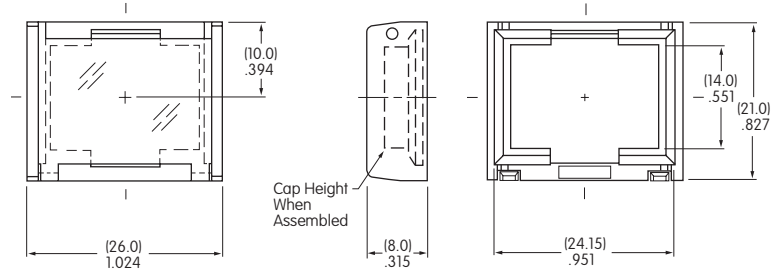

Material: Polyamide

Protective Guards reduce depth of switch behind panel by .020" (0.5mm).

AT4172 Rectangular Protective Guard



Spring Loaded Protective Guard

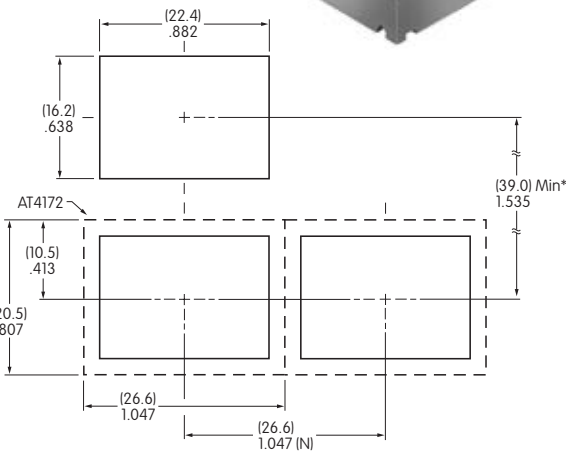
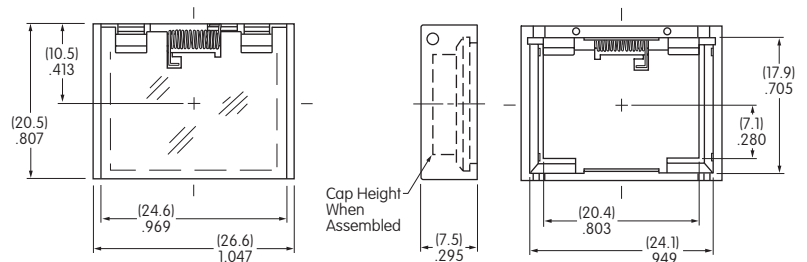

Opens 180°
Closes automatically

Materials:
Cover: Clear Polycarbonate
Base: Black GFR Polyamide
Coil Spring: Stainless Steel

Recommended Panel Thickness:
.039" ~ .106" (1.0mm ~ 2.7mm)

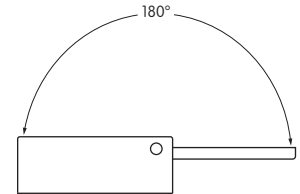

(N) = Number of switches * Minimum dimension allows opening of cover to 180°

Dust Covers

AT4002 Round



AT4001 Square

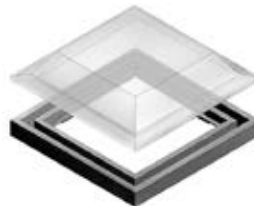

AT4011 Rectangular

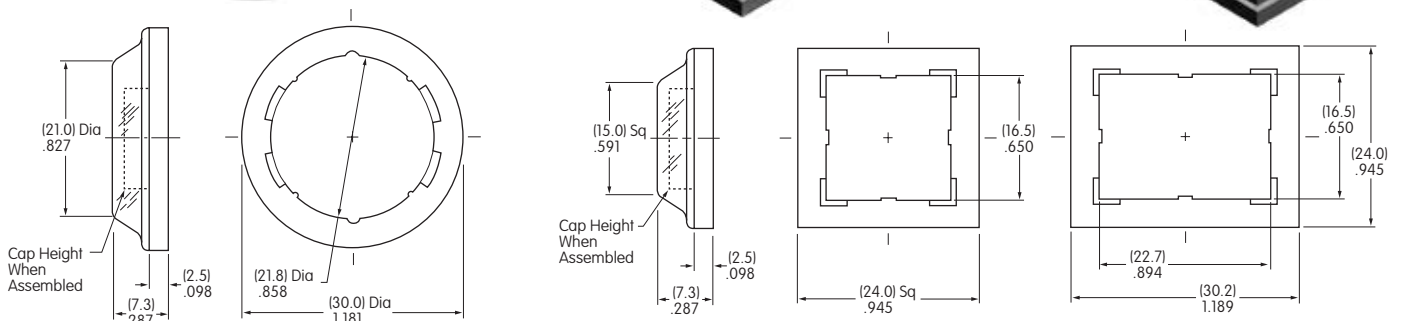
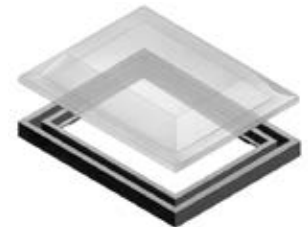

Materials: PVC with polyethylene gasket; PVC loses pliability below 0°C (32°F). Dust Covers reduce depth of switch behind panel by .020" (0.5mm).

General Specifications

Electrical Capacity (Resistive Load)

| | |
|------------------------------|---|
| Power Level (silver): | 3A @ 125V AC or 3A @ 250V AC or 3A @ 30V DC |
| Logic Level (gold): | 0.4VA maximum @ 28V AC/DC maximum (Applicable Range 0.1mA ~ 0.1A @ 20mV ~ 28V) |

Note: Find additional explanation of operating range in Supplement section.

Other Ratings

| | |
|---------------------------------|--|
| Contact Resistance: | 50 milliohms maximum for silver; 100 milliohms maximum for gold |
| Insulation Resistance: | 200 megohms minimum @ 500V DC |
| Dielectric Strength: | 1,000V AC minimum between contacts for 1 minute minimum; 1,500V AC minimum between contacts & case for 1 minute minimum |
| Mechanical Life: | 1,000,000 operations minimum for momentary circuit 200,000 operations minimum for maintained circuit |
| Electrical Life: | 100,000 operations minimum |
| Nominal Operating Force: | 5.39N |
| Contact Timing: | Nonshorting (break-before-make) |
| Travel: | Pretravel .059" (1.5mm); Overtravel .059" (1.5mm); Total Travel .118" (3.0mm) |

Materials & Finishes

| | |
|-----------------------------|---|
| Housing: | Glass fiber reinforced polyamide (UL94V-0) |
| O-ring: | Nitrile butadiene rubber |
| Inner Seal: | Silicone rubber |
| Movable Contact: | Silver alloy or copper with gold plating |
| Stationary Contacts: | Silver alloy or copper with gold plating |
| Base: | Liquid crystal polymer (UL94V-0) |
| Switch Terminals: | Phosphor bronze with silver or gold plating |
| Lamp Terminals: | Brass with silver plating |

Environmental Data

| | |
|-------------------------------------|---|
| Operating Temperature Range: | -25°C through +50°C (-13°F through +122°F) for Illuminated -25°C through +70°C (-13°F through +158°F) for Nonilluminated Note: When used with a polyvinyl chloride splash cover, the lowest limit is 0°C (32°F) |
| Humidity: | 90 ~ 95% humidity for 96 hours @ 40°C (104°F) |
| Vibration: | 10 ~ 55Hz with peak-to-peak amplitude of 1.5mm traversing the frequency range & returning in 1 minute; 3 right angled directions for 2 hours |
| Shock: | 50G (490m/s ²) acceleration (tested in 6 right angled directions, with 5 shocks in each direction) |
| Sealing: | IP65 of IEC60529 standard (similar to NEMA 4 & 13) |

Installation

| | |
|--|--|
| Mounting Torque: | 1.96Nm (17.35 lb·in) maximum |
| Cap Installation Force: | 3.92N maximum downward force on cap |
| Quick Connect Force: | 52.95N maximum downward force on connector |
| Soldering Time & Temperature: | Manual Soldering: See Profile A in Supplement section. |

Standards & Certifications

| | |
|--------------------------------|--|
| Flammability Standards: | UL94V-0 housing & base |
| UL: | File No. E44145 - Recognized only when ordered with marking on switch. Add "/U" or "/CUL" before first dash in part number to order UL recognized switch. All models recognized at 3A @ 125V or 250V AC or 0.4VA @ 28V AC/DC maximum. |
| CSA: | File No. 023535_0_000 - Certified only when ordered with marking on switch. Add "/C" before first dash in part number to order CSA certified switch. All models certified at 3A @ 125V or 250V AC or 0.4VA @ 28V AC/DC maximum. |

TYPICAL SWITCH

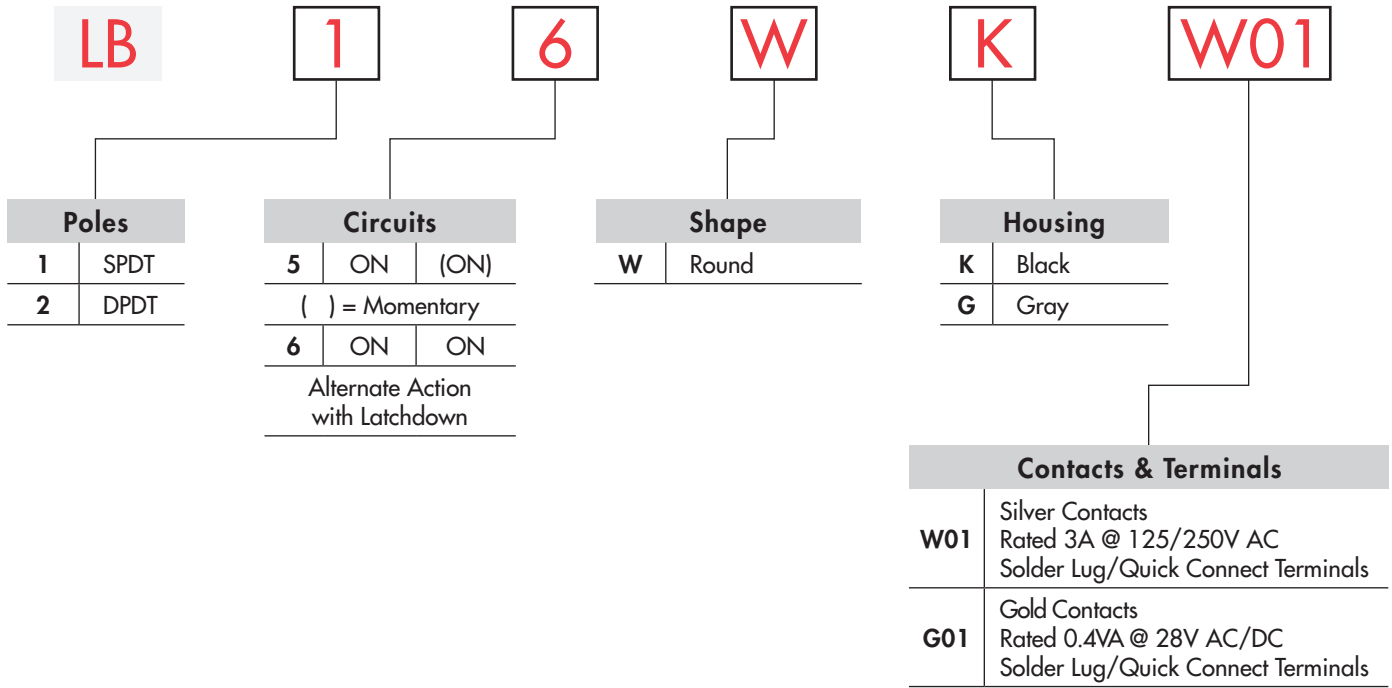

IMPORTANT:



Switches are supplied without UL, cULus & CSA marking unless specified. **UL, cULus & CSA recognized only when ordered with marking on the switch.** Specific models, ratings, & ordering instructions are noted on the General Specifications page.

DESCRIPTION FOR TYPICAL ORDERING EXAMPLE

LB16WKW01-5C12-JC

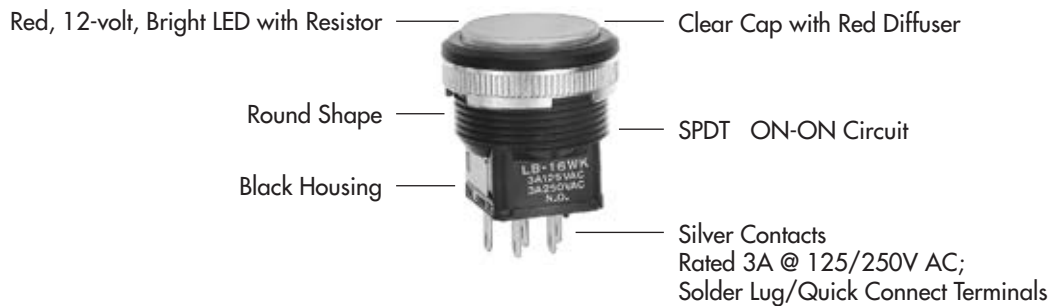

Toggles
Rockers
Pushbuttons
Illuminated PB
Programmable
Keylocks
Rotaries
Slides
Tactiles
Tilt
Touch
Indicators
Accessories
Supplement

ORDERING EXAMPLE

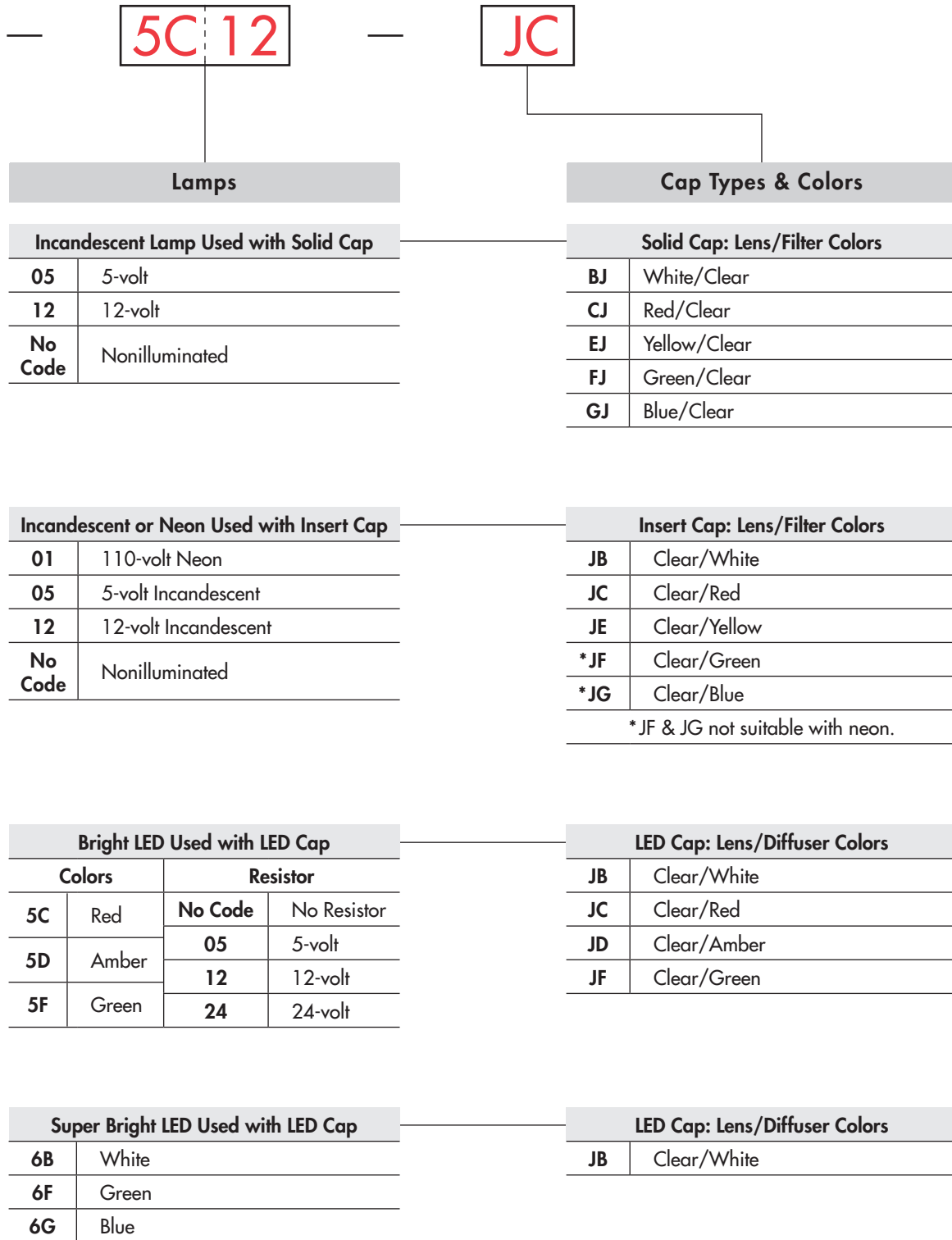

Toggles

Rockers

Pushbuttons

D Illuminated PB

Programmable

Keylocks

Rotaries

Slides

Tactiles

Tilt

Touch

Indicators

Accessories

Supplement

Toggles

Rockers

Pushbuttons

Illuminated PB

Programmable

Keylocks

Rotaries

Slides

Tactiles

Tilt

Touch

Indicators

Accessories

Supplement

POLES & CIRCUITS

| Pole | Model | Plunger Position () = Momentary | | Connected Terminals | | Throw & Switch/Lamp Schematics |
|------|---------------|-------------------------------------|------------|---------------------|---------|---|
| | | Normal | Down | Normal | Down | |
| SP | LB15 *LB16 | ON ON | (ON) ON | 1-3 | 1-2 | Notes: Switch is marked with NC, NO, COM, L+, L-. Lamp circuit is isolated and requires external power source. |
| DP | LB25 *LB26 | ON ON | (ON) ON | 1-3 4-6 | 1-2 4-5 | |

* When in latchdown position for the alternate circuit, cap position is .039" (1.0mm) above the built-in bezel.

SHAPE & PANEL CUTOUT

W .866" (22.0mm)
Round

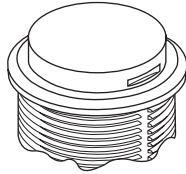

Recommended Panel Thickness:
.039" ~ .157" (1.0mm ~ 4.0mm)

Recommended Panel Thickness with Splash Cover:
.039" ~ .138" (1.0mm ~ 3.5mm)

Overtightening the mounting nut AT074
may damage the switch housing.

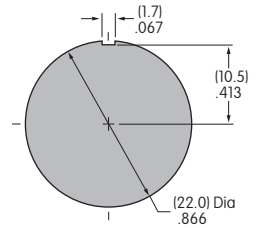

HOUSING

Housing Colors Available:



Black



Gray

CONTACT MATERIALS, RATINGS & TERMINALS

W01

Silver Contacts

Power Level
3A @ 125V AC & 250V AC

Solder Lug/Quick Connect

G01

Gold Contacts

Logic Level
0.4VA max. @ 28V AC/DC max.

Optional PCB adaptors AT711
& AT712 available; illustrated
in previous snap-in subsection.

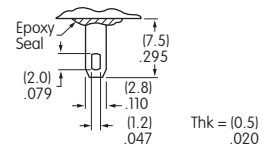

Complete explanation of operating range in Supplement section.

INCANDESCENT & NEON LAMP CODES & SPECIFICATIONS

AT607 & AT607N



T-1 Bi-pin

| | | 05 | 12 | 01 * |
|---------------------|--|---------------|-----------|-------------|
| | AT607 Incandescent 5-volt or 12-volt; AT607N Neon 110-volt | | | |
| Voltage | V | 5V AC | 12V AC | 110V AC |
| Current | I | 115mA | 60mA | 1.5mA |
| Endurance | Avg. Hours | 10,000 | | 10,000 |
| Ambient Temp. Range | | -25°C ~ +50°C | | |



The electrical specifications shown are determined at a basic temperature of 25°C. Lamp circuit is isolated and requires external power source.

* Recommended Resistors for Neon:
33K ohms for 110V AC;
100K ohms for 220V AC

LED COLORS & SPECIFICATIONS

The electrical specifications shown are determined at a basic temperature of 25°C. LED circuit is isolated and requires external power source. Polarity marks are on the switch. If the source voltage exceeds the rated voltage, a ballast resistor is required. The resistor value can be calculated by using the formula in the Supplement section. Additional lamp detail is shown in the Accessories & Hardware section.

Bright LED without Resistor

| | | | | | | | |
|---|-----------------------------------|------------------|--------------------|--------------------|----------------------------|-------|-------|
| AT635 LEDs are colored in OFF state.   T-1½ Bi-pin | Color Codes | Red 5C | Amber 5D | Green 5F | No Code No Resistor | | |
| | Maximum Forward Current | I_{FM} | | | Red | Amber | Green |
| | Typical Forward Current | I_F | | | 30mA | 30mA | 30mA |
| | Forward Voltage | V_F | | | 1.9V | 2.0V | 2.1V |
| | Maximum Reverse Voltage | V_{RM} | | | 5V | 5V | 5V |
| | Current Reduction Rate Above 25°C | ΔI_F | | | 0.42mA/°C | | |
| | Ambient Temperature Range | | | | -25° ~ +50°C | | |

Bright LED with Resistor

| | | | | | | | |
|---|-----------------------------------|------------------|--------------------|--------------------|----------------|-----------|-----------|
| AT627 with Resistor  T-1 Bi-pin | Color Codes: | Red 5C | Amber 5D | Green 5F | Resistor Codes | | |
| | Maximum Forward Current | I_{FM} | | | 05 | 12 | 24 |
| | Typical Forward Current | I_F | | | — | — | — |
| | Forward Voltage | V_F | | | 5V | 12V | 24V |
| | Maximum Reverse Voltage | V_{RM} | | | 4V | 8V | 16V |
| | Current Reduction Rate Above 25°C | ΔI_F | | | 0.50mA/°C | | |
| | Ambient Temperature Range | | | | -25° ~ +50°C | | |

AT627
5-volt
4-element
with Resistor

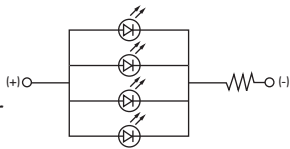

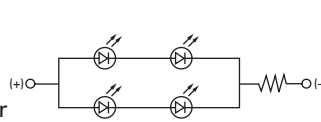

AT627
12-volt
4-element
with Resistor

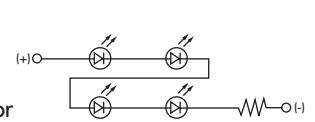

AT627
24-volt
4-element
with Resistor

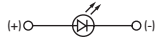

Super Bright Single Element LED

| | | | | | | | |
|--|---|--------------|--|--------------|-----------|-----------|-----------|
| AT625G Blue AT631B White AT632F Green   T-1 Bi-pin |  | | | 6B | 6F | 6G | |
| | Color | | | White | Green | Blue | |
| | Maximum Forward Current | I_{FM} | | | 30mA | 30mA | 30mA |
| | Typical Forward Current | I_F | | | 20mA | 20mA | 20mA |
| | Forward Voltage | V_F | | | 3.3V | 3.3V | 3.3V |
| | Maximum Reverse Voltage | V_{RM} | | | 7V | 7V | 7V |
| | Current Reduction Rate Above 25°C | ΔI_F | | | 0.40mA/°C | 0.40mA/°C | 0.40mA/°C |
| Ambient Temperature Range | | | | -25° ~ +50°C | | | |

No Code

No Lamp

CAP TYPES & COLOR COMBINATIONS

Color Codes: B White C Red D Amber E Yellow F Green G Blue J Clear

Solid Cap for Incandescent Lamp & Nonilluminated

Lens/Filter
Colors Available:

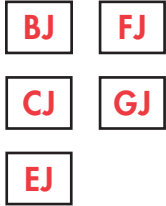

AT4054

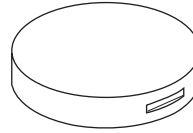
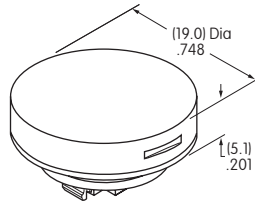

Translucent
Colored Lens

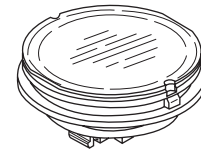

Transparent
Clear Filter



Lamp
AT607

Material: Polycarbonate Finish: Glossy

Insert Cap for Incandescent or Neon Lamp & Nonilluminated

Lens/Filter
Colors Available:

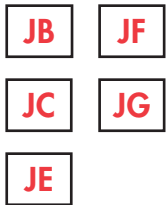

AT4055

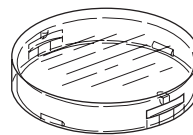
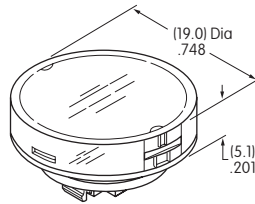

Transparent
Clear Lens

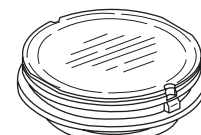

Translucent
Colored Filter



Lamp
AT607



Lamp
AT607N

JF and JG not suitable
with neon lamp.

Material: Polycarbonate Finish: Glossy

Cap for Bright LED without Resistor

Lens/Diffuser
Colors Available:



AT4179

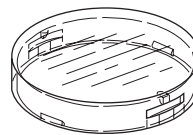
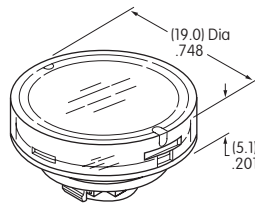

Transparent
Clear Lens

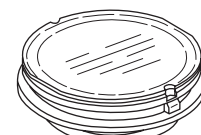

Translucent
Colored Diffuser



Bright LED
AT635

Material: Polycarbonate Finish: Glossy

Cap for Bright LED with Resistor

Lens/Diffuser
Colors Available:



AT4165

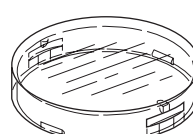
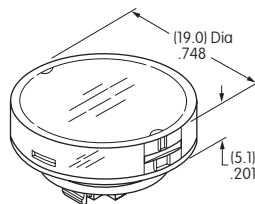

Transparent
Clear Lens

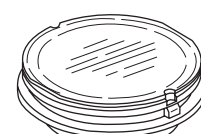

Translucent
Colored Diffuser

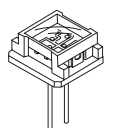

Bright LED
AT627

Material: Polycarbonate Finish: Glossy

CAP TYPES & COLOR COMBINATIONS

JB

**Clear Lens
White Diffuser**

Material:
Polycarbonate
Finish: Glossy

AT4131

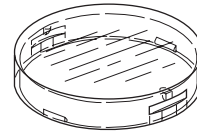
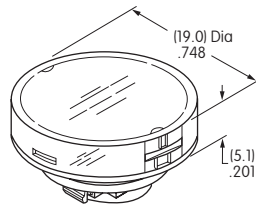

Transparent
Clear Lens

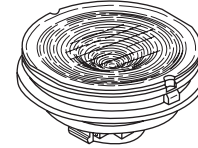

Translucent
Colored Diffuser



LEDs
AT625
AT631
AT632

TYPICAL SWITCH DIMENSIONS

Single & Double Pole

Panel Seal

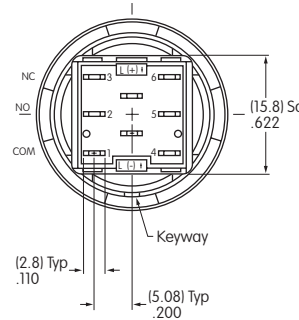
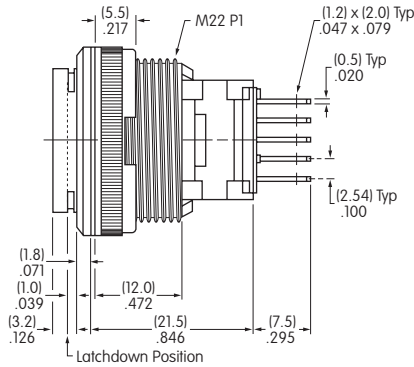
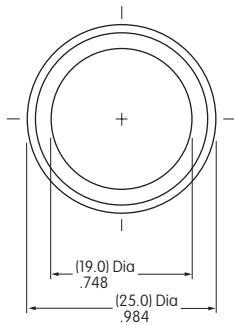

Single pole models do not have terminals 4, 5, & 6.

LB25WKW01-12-JC

OPTIONAL ACCESSORIES

AT9410 Splash Cover for Panel Seal

Materials:

Lid: PVC (loses pliability below 0°C/32°F)

Base: Polyethylene

O-ring: NBR

Recommended Panel Thickness:

.039" ~ .138" (1.0mm ~ 3.5mm)

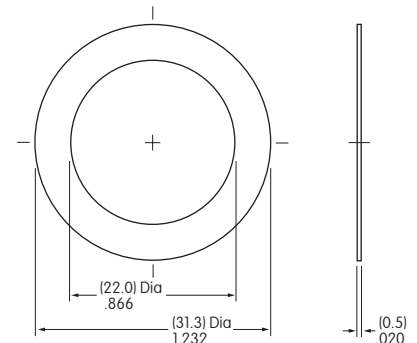
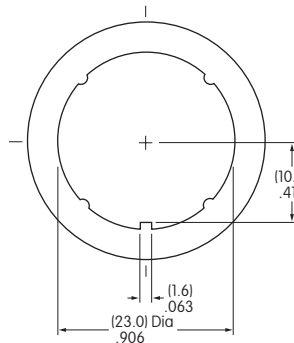
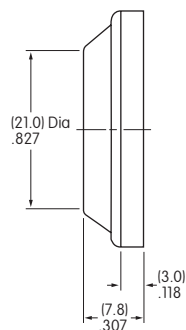
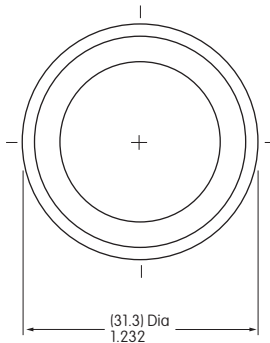
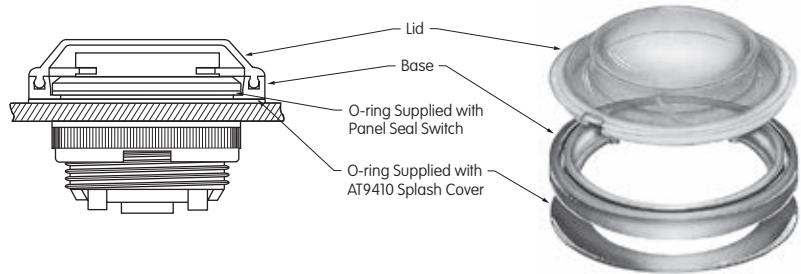

Toggle
Rockers
Pushbuttons
Illuminated PB
Programmable
Keylocks
Rotaries
Slides
Tactiles
Tilt
Touch
Indicators
Accessories
Supplement

ASSEMBLY INSTRUCTIONS

Lamp Installation & LED Orientation

Incandescent & Neon Lamps AT607 & AT607N

Align projections on lamp with grooves (B) in holder when inserting lamp. To correctly join the lamp holder and cap base, match the cut corners (A).

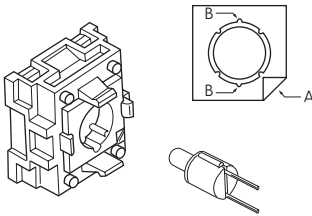

Bright LED AT627

Panel Seal Models

For panel seal models, Bright LED must first be inserted into the lamp socket which is built into the switch. The cap can then be placed on the switch.

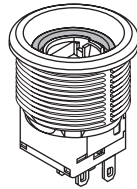

Snap-in Models

For snap-in models, Bright LED must be inserted into the cap first. Align cut corners (C) when inserting the LED.

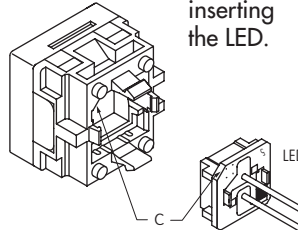

Bright & Super Bright LEDs AT625, AT631, AT632, AT635

Align D-flat on LED with flat (B) in holder when inserting the LED. To correctly join the lamp holder and cap base, match the cut corners (A).

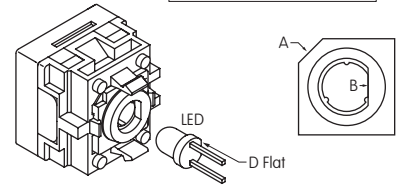

Switch & Cap Assembly

Round & Rectangular

Match clip on cap assembly with receptacle inside switch. Lamp terminals will then be aligned correctly with lamp socket.

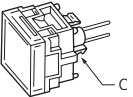
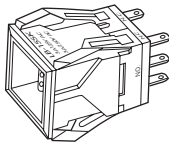
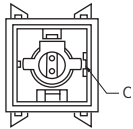

Square

Match projection (C) on cap assembly with groove (C) inside switch. Lamp terminals will then be aligned correctly with lamp socket.

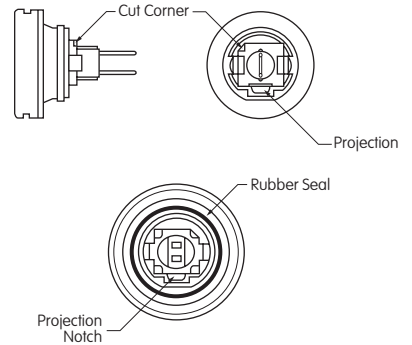
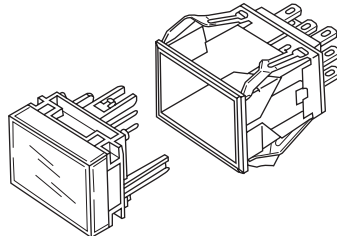
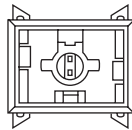

Panel Seal

With Lamps AT607, AT607N, and LEDs AT614, AT625, AT631, AT632: Match projection on cap assembly with notch inside switch. Lamp terminals will then be aligned correctly with lamp socket.

Installation & Maintenance

Snap-in Mount

Snap-in clip holds all switches firmly in place. To mount round switch, match the antirotation projection on switch with guide cut in panel. Snap into panel cutout.

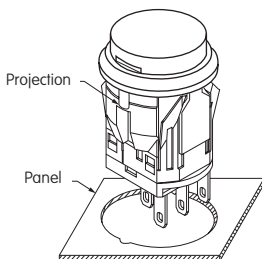

Panel Seal Bushing Mount

Insert switch from the front of the panel with the o-ring between the built-in bezel and the panel. Install mounting nut AT075 (supplied with switch) from the rear of the panel. Overtightening mounting nut may damage the switch housing.

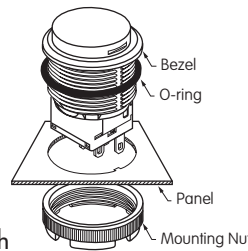

Lamp Replacement

Actuator must be in UP position. Pull off cap with cap extractor AT109. Replace lamp and reassemble as shown above.



AT109
Cap Extractor



AT112
Socket Wrench

LEGENDS

NKK Switches can provide custom legends for caps. Contact factory for more information.

Suggested Printable Area for Lens

Recommended Methods: Laser Etch on clear lens, Screen Print, or Pad Print on lens.

Epoxy based ink is recommended.

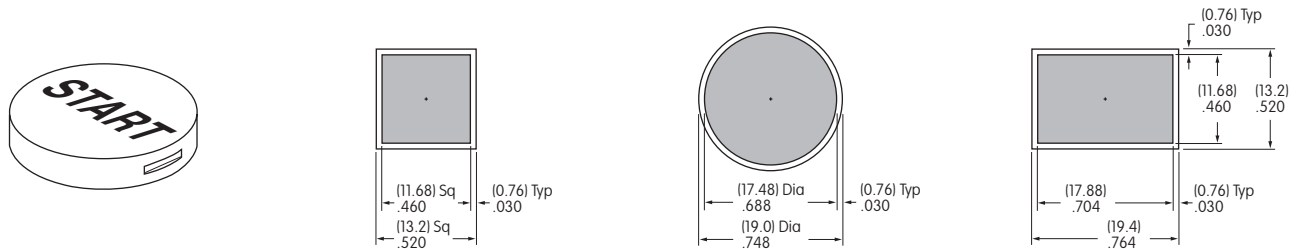

Shaded areas are printable areas.

Suggested Printable Area for Film Insert

Recommended Print Method: Laser Print or Screen Print with Epoxy based ink

Film Insert: Clear Polyester, 4 mil max. thickness

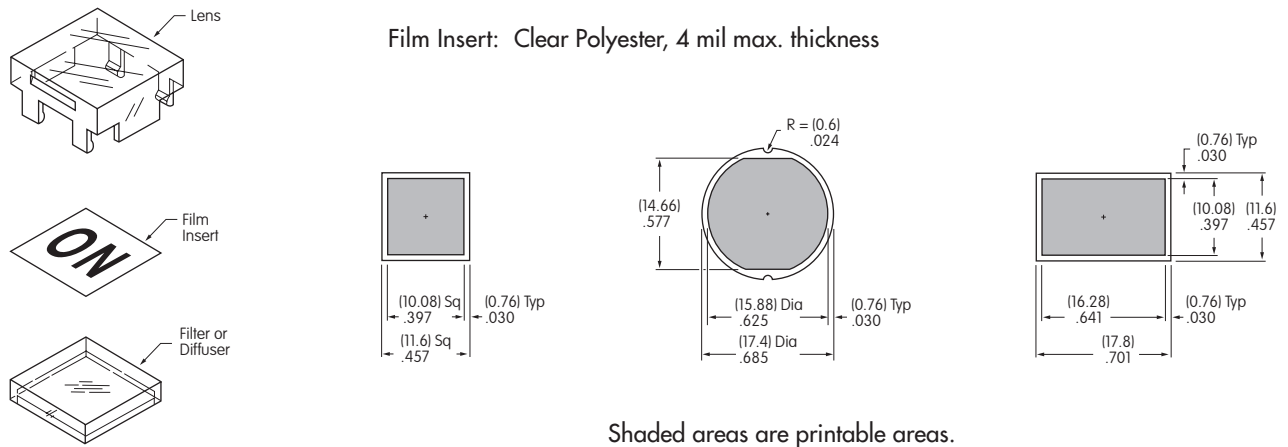

Shaded areas are printable areas.

Mouser Electronics

Authorized Distributor

Click to View Pricing, Inventory, Delivery & Lifecycle Information:

NKK Switches:

[LB26WKG01-5C-JB](#) [LB16RKW01-05-BJ](#) [LB16RKW01-05-FJ](#) [LB15CKW01-12-EJ](#) [LB26WGG01-5F-JF](#)
[LB26WGG01-5F-JB](#) [LB26WGW01-5F-JF](#) [LB25CKW01-05-BJ](#) [LB25CKW01-05-FJ](#) [LB16RKW01-05-GJ](#) [LB16RKW01-05-CJ](#) [LB25CKW01-05-GJ](#) [LB15CKW01-5C05-JB](#) [LB25WKG01-5F24-JB](#) [LB26RKW01-05-EJ](#) [LB26RKW01-05-BJ](#)
[LB16RKW01-12-BJ](#) [LB15WGG01-FJ](#) [LB15WGG01-GJ](#) [LB15WGG01-EJ](#) [LB26WGW01-5D-JB](#) [LB26WGG01-5D-JB](#)
[LB26WGG01-5D-JD](#) [LB26CKW01-05-BJ](#) [LB26WGW01-5D-JD](#) [LB16WGW01-6G-JB](#) [LB16WGG01-6G-JB](#)
[LB15WGG01-6F-JB](#) [LB16WGG01-5D-JD](#) [LB25WGW01-BJ](#) [LB25WGW01-FJ](#) [LB16WGG01-5D-JB](#) [LB16WGW01-5D-JD](#) [LB16WGW01-5D-JB](#) [LB16SKW01-05-CJ](#) [LB16SKW01-05-GJ](#) [LB26SKW01-05-EJ](#) [LB15WGG01-6G-JB](#)
[LB25SKW01-05-GJ](#) [LB25SKW01-05-EJ](#) [LB25SKW01-05-CJ](#) [LB25WKG01-5F-JB](#) [LB26RKW01-12-GJ](#) [LB25WKG01-5D-JB](#) [LB16RKW01-05-EJ](#) [LB25WKG01-5D-JD](#) [LB25WKW01-5D-JB](#) [LB25WKW01-5F-JB](#) [LB25WKW01-5C-JB](#)
[LB25WKG01-5C-JB](#) [LB25WGG01-5C-JC](#) [LB25WGG01-5C-JB](#) [LB25WGW01-5C-JB](#) [LB15CKW01-05-CJ](#)
[LB15WKW01-5D-JB](#) [LB25WGG01-6F-JB](#) [LB25WGW01-6F-JB](#) [LB25WKG01-6F-JB](#) [LB26WKW01-5D-JB](#)
[LB15RKW01-12-GJ](#) [LB26WKG01-5D-JB](#) [LB25WGW01-GJ](#) [LB25WGW01-CJ](#) [LB16CKW01-05-BJ](#) [LB25WGW01-EJ](#)
[LB16WKG01-5D-JB](#) [LB26RKW01-12-EJ](#) [LB16WGW01-5F-JB](#) [LB16WGG01-5F-JB](#) [LB16WGW01-5F-JF](#)
[LB16WGG01-5F-JF](#) [LB16WGW01-5C-JB](#) [LB16WGG01-5C-JB](#) [LB16WGG01-5C-JC](#) [LB16WGW01-5C-JC](#)
[LB26WKG01-5F-JB](#) [LB26WGG01-6G-JB](#) [LB15WGW01-5C-JC](#) [LB15WGG01-5C-JB](#) [LB26WGW01-5C-JB](#)
[LB26WGG01-5C-JB](#) [LB26WGW01-5C-JC](#) [LB26WGG01-5C-JC](#) [LB25WGW01-5F-JB](#) [LB25WGW01-5F-JF](#)
[LB25WGG01-5F-JF](#) [LB25WGG01-5D-JD](#) [LB25WGW01-5D-JD](#) [LB25WGG01-5D-JB](#) [LB25WGW01-5D-JB](#)
[LB16CKW01-5F-JB](#) [LB16SKW01-12-BJ](#) [LB15RKW01-05-FJ](#) [LB15RKW01-05-GJ](#) [LB16CKW01-28-CJ](#) [LB25CKW01-12-FJ](#) [LB16CKW01-12-EJ](#) [LB16CKW01-12-GJ](#) [LB15WGW01-5D-JB](#) [LB15WGG01-5D-JB](#)