

Features

- Simple drop in solution full GNSS receiver (GPS/GLONASS/GALILEO/BEIDOU)
- MediaTek MT3333 Flash chip
- Ultra-small SMD package; 13.8 x 9.5 x 1.8mm
- Low current consumption
- AIC, Active Interference Cancellation
- EASY - Internally generated orbit prediction for fast fix times.

Description

A compact GPS module receiver using the MediaTek MT3333 flash chip providing a complete GNSS receiver for optimum performance. The module can run three GNSS systems simultaneously to enhance location and TTFF considerably. The M20050 operates on a versatile 2.8V-4.2V supply with low power consumption and several low power modes for further power savings. An accurate 0.5ppm TXCO ensures short TTFF. Indoor and outdoor multi-path detection and compensation.

Applications

- Wearable devices
- Portable devices
- Asset tracking / personal safety
- Sports cameras / equipment
- Smart watches
- Navigation devices



Part number

M20050-1

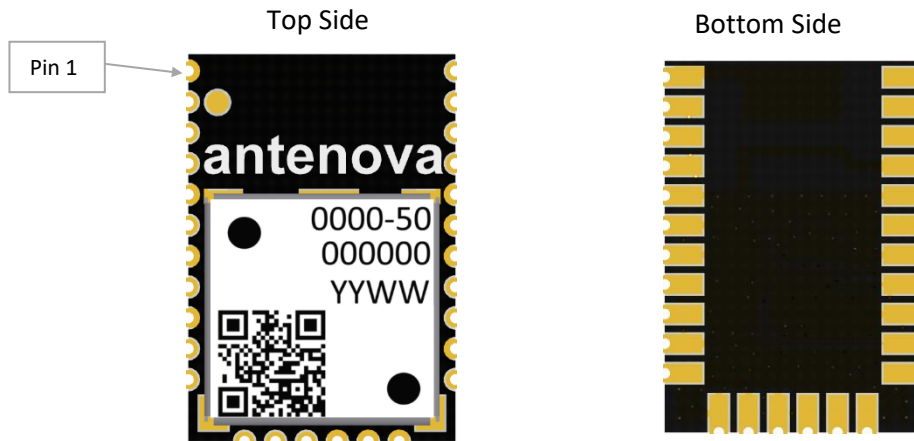

Functional Block Diagram

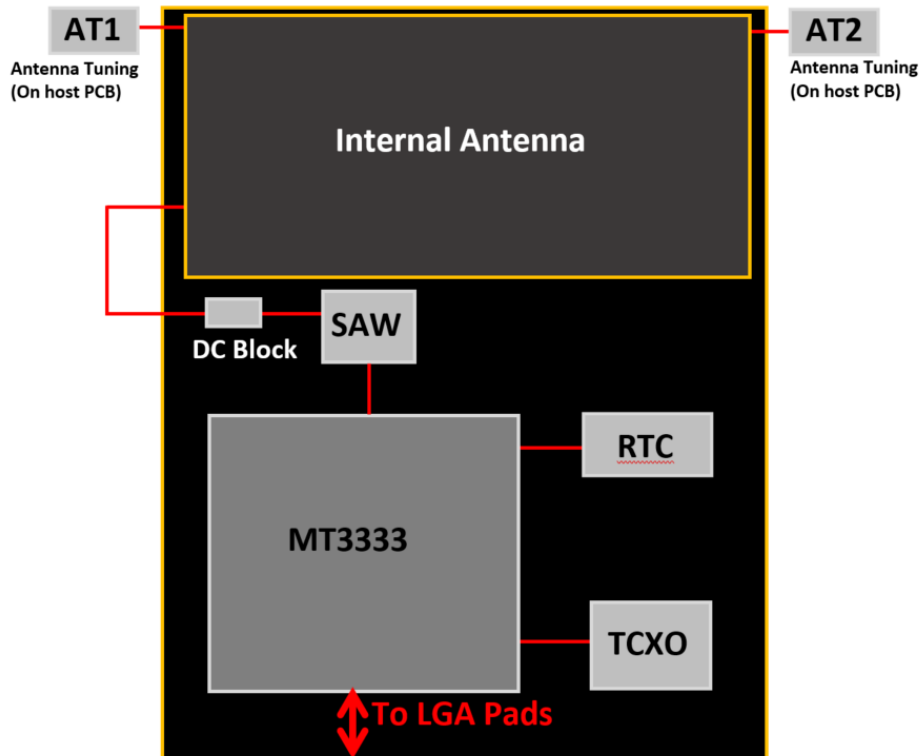

Module Specifications

Absolute Maximum Ratings

Symbol	Parameter	Min	Max	Unit
V_{CC}	Main Supply Voltage	-0.3	4.3	V
V_{IO}	Supply voltage I/O ring	-0.3	3.6	V
V_{BATT}	VBCKP Supply	-0.3	4.3	V
RF_{IN}	Maximum RF Input Power	N/A	+10	dBm
T_{STG}	Storage Temperature	-40	+85	°C
T_A	Operating Temperature	-40	+85	°C

* Exposure to absolute ratings may adversely affect reliability and may cause permanent damage.

Recommended Operating Conditions

Symbol	Parameter	Min	Typ	Max	Unit
V_{CC}	Main Supply Voltage	2.8	3.3	4.3	V
V_{BATT}	VBCKP Supply	2.8	3.3	4.3	V
T_{OP}	Operating Temperature	-40	-	+85	°C

DC Electrical Characteristics

Conditions: $V_{CC} = 3.3V$, $T_{OP} = 25\text{ °C}$

Symbol	Parameter	Typ	Unit
$I_{CC(PK)}$	Peak Acquisition Current	29	mA
$I_{CC(AVG)}$	Average Tracking Supply Current	21	mA
$I_{CC(STBY)}$	Standby (Sleep) Power Supply Mode	<500	μA
$I_{CC(BCKUP)}$	Backup Mode	7	μA

RF Specifications

Conditions: $V_{CC} = 3.3V$, $T = 25\text{ °C}$, Freq = 1575.420MHz

Symbol	Parameter	Typ	Unit
NF_{LNA}	LNA Noise Figure	2.0	dB
ANT_{RL}	Antenna Return Loss	<-7.0	dB
ANT_{BW}	Antenna Bandwidth at -7dB return loss	65	MHz
ANT_{EFF}	Antenna Total Efficiency	>57%	%
ANT_{EFF_RHCP}	Antenna RHCP Efficiency	>28%	%

Band Rejection

Frequency	Standard	Typ*	Unit
698-798	LTE700	43	dB
824-849	Cellular CDMA	43	dB
869-894	GSM850	43	dB
880-915	GSM900	43	dB
1710-1785	GSM1800/DCS	44	dB
1850-1910	GSM1900/PCS	46	dB
1920-1980	WCDMA	46	dB
2400-2492	WLAN, BT and WiMAX	50	dB
2500-2690	LTE2600	52	dB

*Does not include antenna rejection.

Mechanical Specifications

Parameter	Typ	Unit
Module exterior dimensions (L x W x H)	13.8 (±0.1) x 9.5 (±0.1) x 1.8 (+0.2 / - 0.0)	mm
Module support and connection	Surface mounted (SMD)	-
Module mass	<1	g

System Specifications

Communication	Specification
Data Output Protocol	NMEA 0183
Host Interfaces	UART
Default data rate on UART	9600 default rate, modify by input command
GPS Engine	
Chip	MTK MT3333 FLASH Chip
Channels	210 PRN / 66 Acquisition / 22 Tracking
TCXO	0.5ppm
Accuracy	
Horizontal Position Accuracy	<2.5m CEP
Maximum Position Update Rate	10 Hz (Default 1Hz)
Sensitivity	
Acquisition (Cold)	-148dBm
Acquisition (Hot)	-163dBm
Tracking	-165dBm
TTFF	
Hot Start	<1s
Warm Start	<25s (typical)
Cold Start	<35s (typical)
General	
Maximum Altitude	<18.000 km
Maximum Speed	<514 m/s
Active Interference Cancellers	12 multi tone active cancellers ISSCC2011 award
Additional Features	1PPS Sync
EPO / EASY	Orbit prediction

50% CEP, Open-Sky, 24hr Static, -130dBm, good view of the sky

Pin out Description

Table shows the designation and function of each pin on the M20050-1 module.

Pin	Designator	Description
1	AT1	Tuning Left side
2	GND	Ground connection
3	GND	Ground connection
4	ANT_OUT	RF from internal antenna to external pin (Connect to pin 6)
5	GND	Ground connection
6	ANT_IN	RF Input from antenna
7	GND	Ground connection
8	VCC	Main DC supply, +2.8V to +4.2V
9	GND	Ground connection
10	HW_R	System reset, active low
11	TM	1PPS Time Mark Out
12	BV	Backup Voltage +2.0V to +4.2V
13	E2	Not used
14	E3	Not used
15	GND	Ground connection
16	GND	Ground connection
17	GND	Ground connection
18	FIX	Indicates once a GPS fix has been obtained.
19	GND	Ground connection
20	TX	UART Transmit data line
21	RX	UART Receive data line
22	GND	Ground connection
23	GND	Ground connection
24	GND	Ground connection
25	GND	Ground connection
26	HW_S	Used to enable standby mode. If not used leave floating.
27	GND	Ground connection
28	AT2	Tuning Right Side

Mechanical

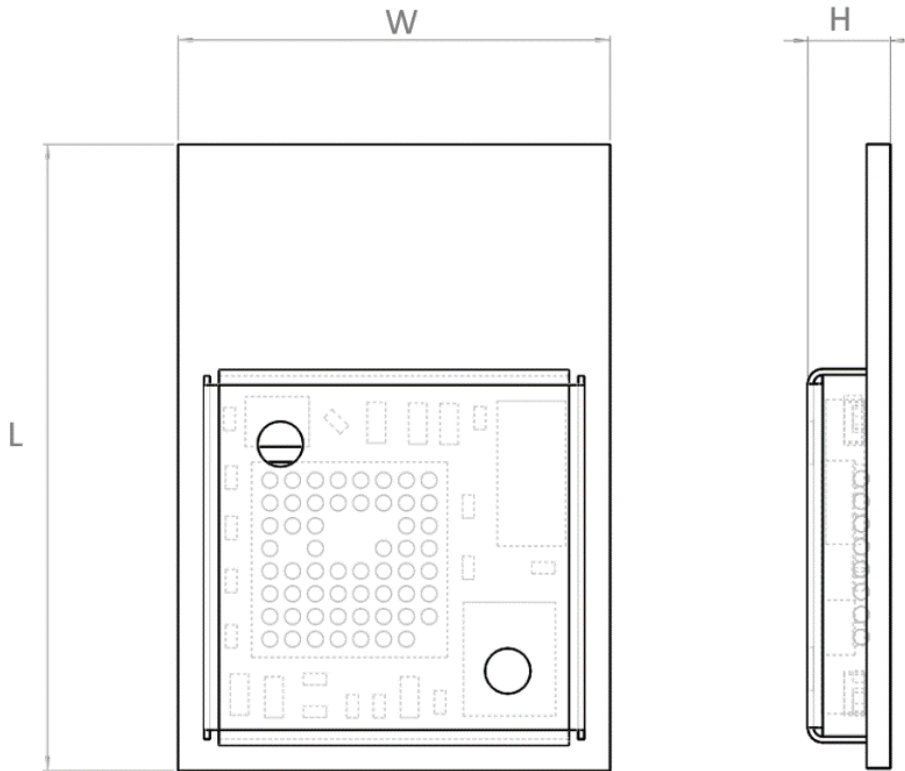

All dimensions in mm

L	W	H
Length	Width	Height
13.8 ±0.1	9.5 ±0.1	1.8 +0.2 / - 0.0

Application Schematic Example for M20050-1:

The circuit below shows a basic design for use with the UART interface and configuring the default baud rate to 9600.

Baud Rate = 9600 (Default)

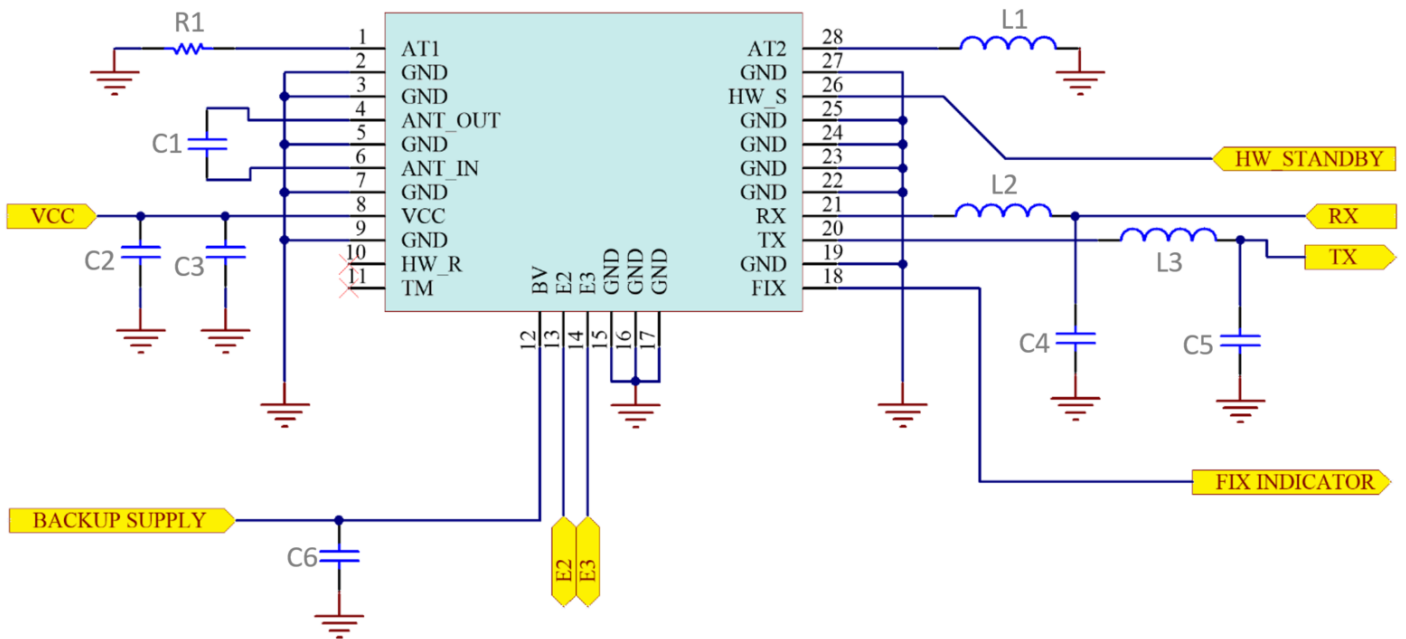

Bill of Material

Designator	Value	Description/Comments	Quantity
C1, C2, C4, C5, C6	22pF capacitor	Decoupling cap. Place close to corresponding pin	5
C3	2.2uF capacitor	Decoupling cap. Place close to corresponding pin	1
L1	1.8nH	Tuning Inductor for antenna	1
L2, L3	47nH Inductor	Filter component	2
R1	0R Resistor	Tuning Resistor for antenna	1

Host Interface

UART Interface

The UART converts bytes of data to and from asynchronous start -stop bit streams as binary electrical impulses. The port contains a 16-byte FIFO, and 256 bytes of URAM. The bit rates are selectable from 4800, 9600, 38400 and 115200 bps.

The IO level from the UART port are CMOS compatible, however for RS232 compatibility the use of external level shifters will be required. The hardware configuration of the port baud can be changed dynamically by the use of commands. These will be active and saved as long as the VBACKP supply is applied.

Power Supply

The M20050-1 uses two DC supply inputs, VBACKUP to power the RAM and RTC sections of the receiver, and VCC to power the digital and processing sections. VBACKUP is to be applied all the time to keep these sections alive. VCC can be removed to initiate a backup power save mode (See page 10). VBACKUP can be removed if a battery is also used at VBACKUP to maintain this supply. The supply is internally regulated for 2.8V meaning the external supply is versatile for a range of voltage levels.

TM (1PPS)

TM is a one pulse per second output from the receiver providing uses for timing purposes. The pulse width is 100ms.

HRST (Hardware Reset Pin)

The External reset pin is default high by an internal 75Kohm and should be left floating if not used. To initiate a reset the pin needs to be pulled low. The module also initiates a reset if the VCC drops below the minimum 2.8V supply.

Power Management

The M20050-1 has three power saving modes.

- Standby mode
- Back up mode
- Periodic mode

Standby Mode

Standby mode is a power saving mode that shuts down the RF section of the module and puts the processor into a standby mode. The RTC is kept alive and the RAM power is maintained to keep the module configuration.

The standby state can be initiated either with a hardware signal to Pin26 or by using a command.

Hardware controlled Standby:

Enable standby mode by a low state to pin 26 (HW_S). To wake the module back to full power a high state needs to be applied to pin 8. If Pin 8 is not to be used then it must be kept floating (not connected).

Standby mode command:

Software on the host needs to send the "PMTK161 command through the UART interface.

Command	M20050-1 standby then wakeup	Current consumption (Typ)
\$PMTK161,0*28	M20050-1 enters standby mode	<500uA
Any byte	M20050-1 wakes up from standby mode	

Back up mode

To enter backup mode the VCC simply needs to be removed. Once initiated the RTC and all configuration is saved along with any ephemeris data to allow quick TTFF once the VCC is re-applied. BV needs to be applied always for backup mode to run correctly.

Periodic mode

Periodic mode is a module controlled mode that reduces current consumption by only waking the module for short periods to maintain fix data. The periodic state is user configured. Contact Antenova for more information and a user command manual.

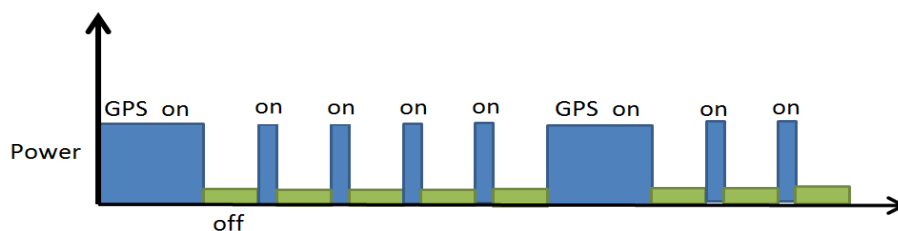

PMTK225 setting	M20050-1 time off/awake	Current usage (Typ)
PMTK225, 2,3000,18000,72000	Module sleeps for 12secs, then wakes for 3secs periodically. 72000 is for a cold boot condition.	<500uA

EPO (Extended Prediction Orbit) data service

The EPO allows the use of up to a 30-day orbit prediction that can be used to aid the module for an instant fix solution.

- A proxy server on the customer's side to update EPO files from the MTK server daily.
- Application software to access the proxy server through the internet (optional if host device can access internet)
- Software on host device to send EPO data to M20050-1 module to allow instant fix by using EE data. Please contact Antenova for more information. Requires permission from MTK to use service.

EASY (Self-Generated Orbit prediction)

The module supports EASY™ (Embedded Assisted System) is a Self-Generated Orbit Prediction feature. It provides up to 3 days GPS orbit prediction ability without the need for any host CPU porting or internet connection requirements.

EASY works as embedded software which accelerates TTFF by predicting satellite navigation messages from received ephemeris. EASY is a fully automated receiver task that is efficiently scheduled and computed in free time of every second after a GNSS navigation solution.

EASY is default off and can be enabled by a PMTK command.

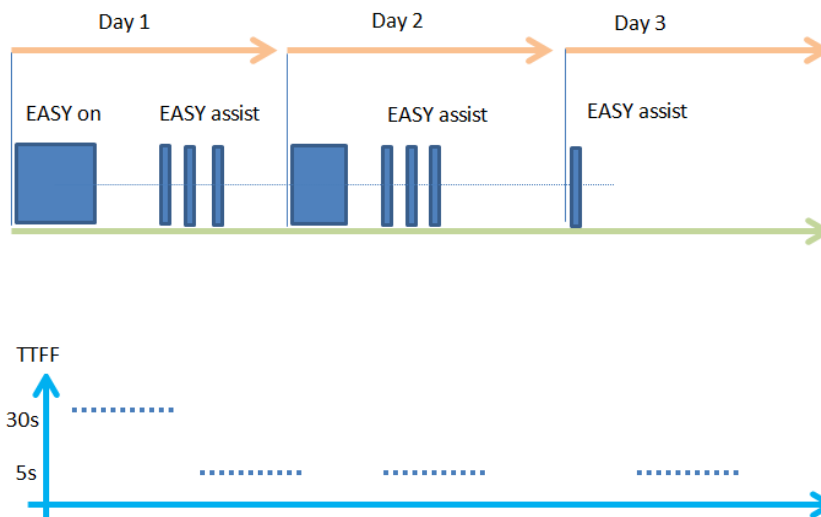

AIC (Active Interference Cancellation)

The AIC feature provides effective narrow-band interference and jamming elimination. The GPS signal can be recovered from the jammed signal and allows users to obtain better navigation quality. This can be beneficial since many of today's devices have increasing functionality with regards to transmitters with many on-board antennas.

External Matching

The M20050-1 module uses matching circuit components on the host PCB to fine-tune the on-board antenna to each specific application. This “external matching” allows compensating for the detuning of the antenna caused by various components that can be close to the M20050-1 module in the actual application (plastic case, battery, speakers etc).

The external matching must be placed on the host PCB from pads AT1(Pad 1) and AT2 (Pad 28). A single component from each pin to GND is all that is required. This should be placed close to the modules pads.

Schematic

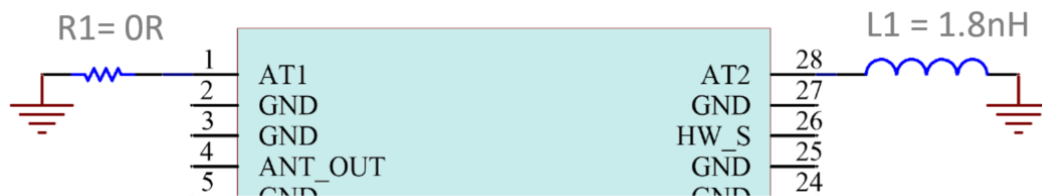

In the example above AT1 only required a 0R resistor and AT2 uses a small 1.8nH inductor to tune the antenna. Both components should be designed in as both may be required for the intended device.

Type of Matching Components

- Capacitors:
 - Use 0402, COG components
- Inductors:
 - High-Q, wire wound inductors in 0402 sizes are recommended for maximum performance, e.g. Murata LQW15 series
 - Good quality multi-layer type inductors (e.g. Murata LQG15 series) can also be used as a lower cost alternative

External Antenna Support

A low cost external circuit can be used to provide external antenna support. Please contact Antenova for more information, and example circuit.

Internal Antenna Clearance

The M20050-1 module internal antenna requires a small clearance on the host PCB to operate. The clearance means that no Ground or tracks of any kind can be within this area. This must also be clear through the entire PCB stack up. The minimum area needed clear is 6mm X 4.87mm.

Top view of M20050-1 host PCB footprint

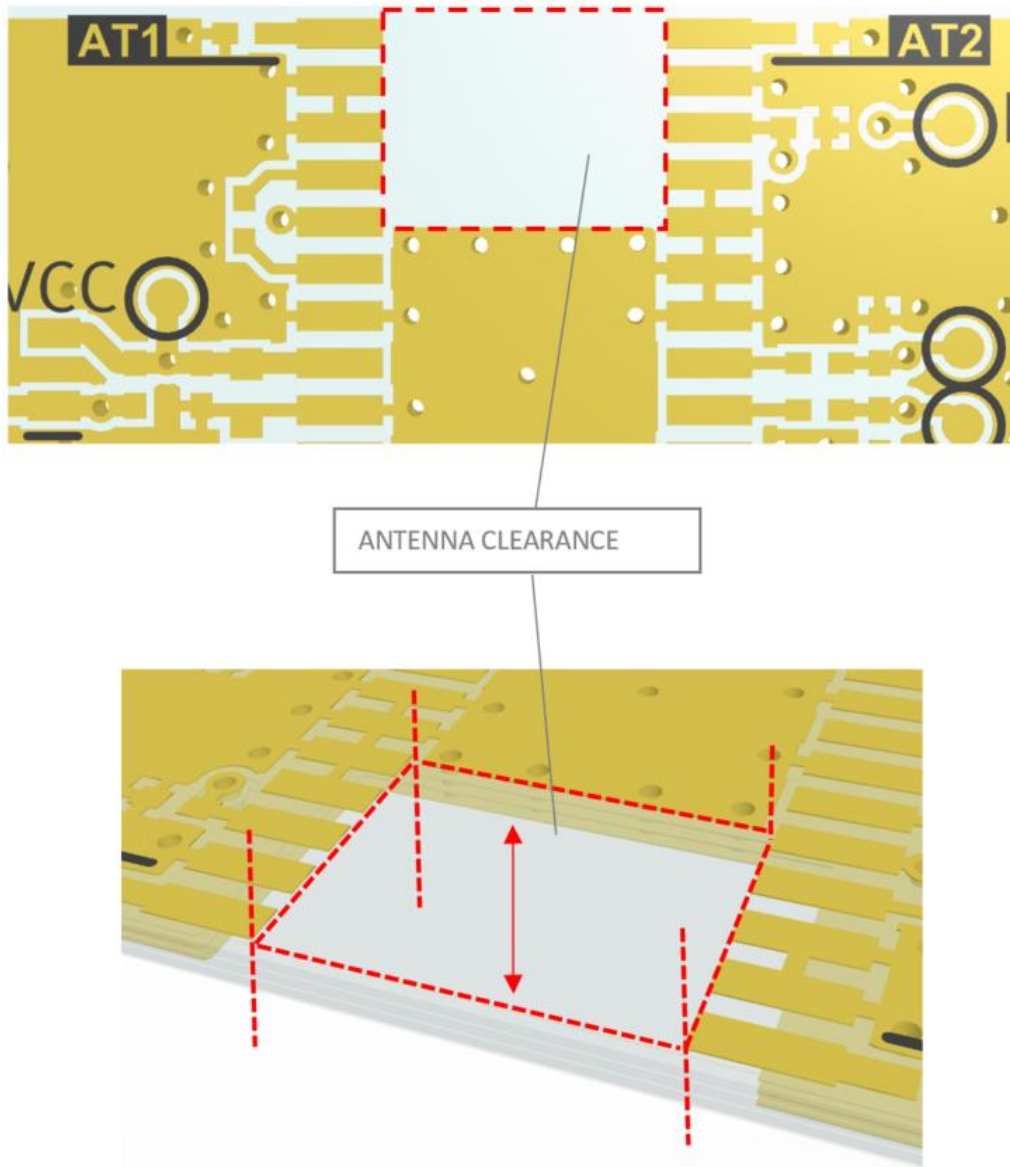

Typical Antenna Matching Results

Typical antenna matching as seen by ANT_IN (Pin 3) is shown in the following plot. The matching bandwidth at -7dB is typically 65MHz. Measured on M20050-EVB-1 test board.

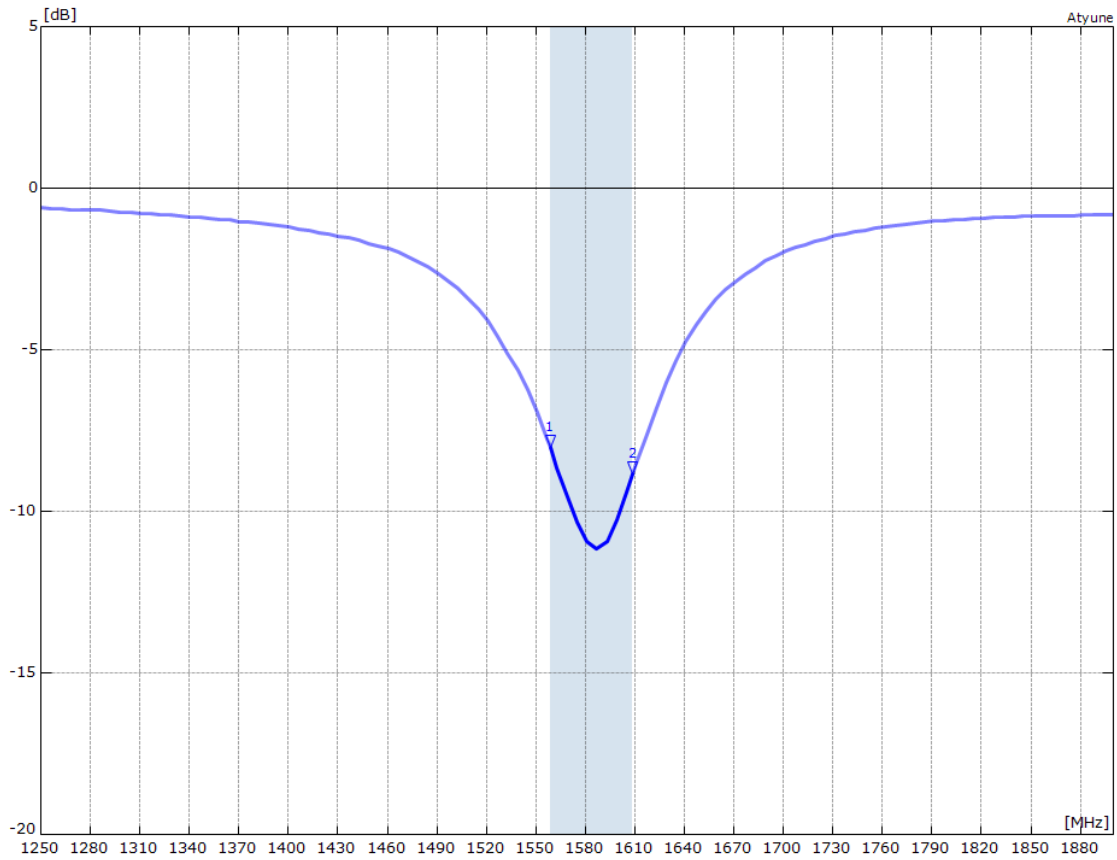

Front-end Rejection

The figure below shows the rejection for the input SAW filter before the RF input, including the effect of pads, tracks, and decoupling. The plot can be useful to calculate the isolation required from adjacent transmitters to avoid the saturation of the LNA.

Input SAW Rejection – Wideband

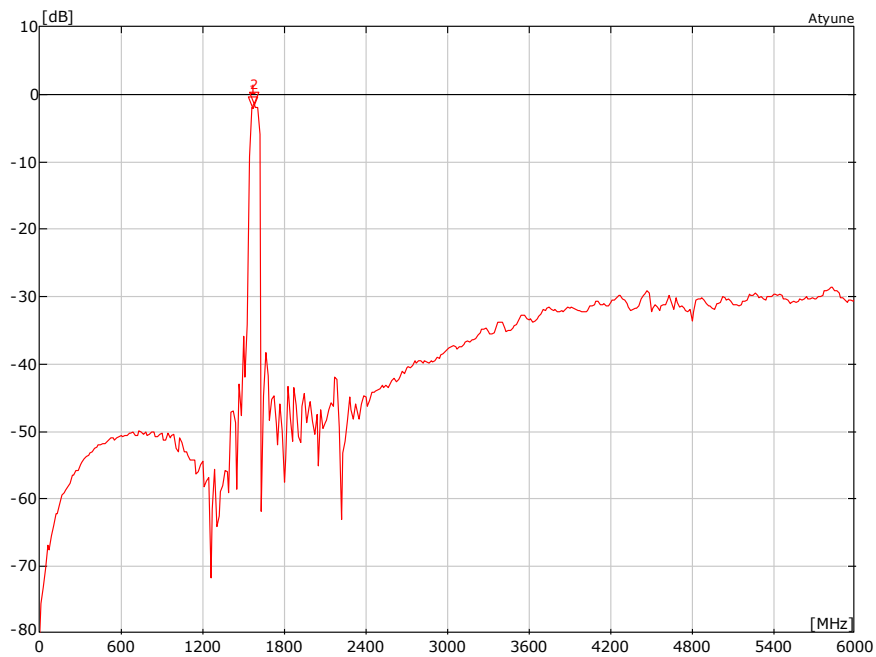

Input SAW Rejection - Narrowband

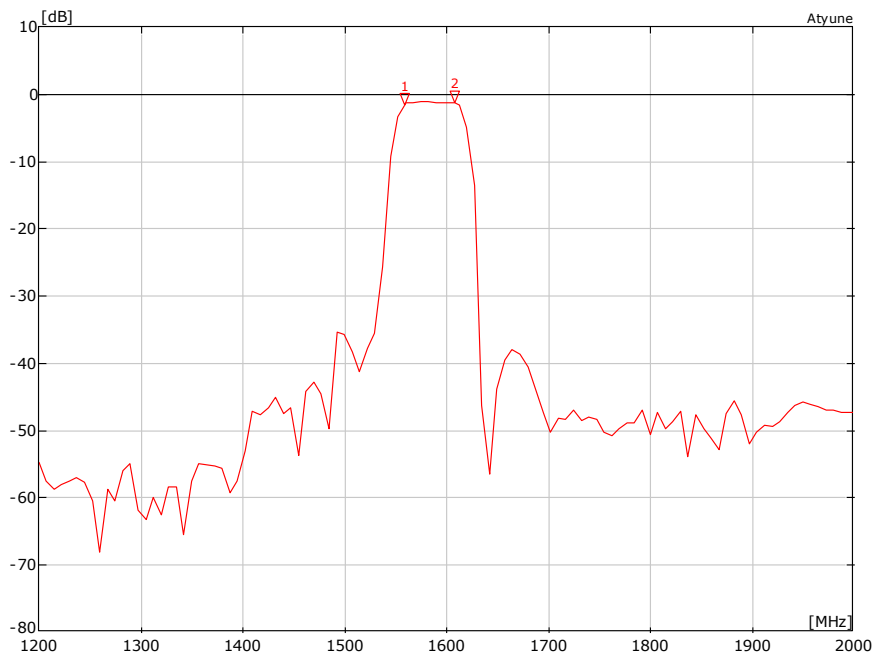

Module Placement Guidelines

Due to the internal antenna, care must be taken when defining the placement of the module on the host PCB. Here are some guidelines that should be used when deciding the position of the module.

- The module top edge must be placed almost level with the edge of the host PCB
- The edge of the host PCB that the module is to be placed at must be a minimum of 40mm in length.

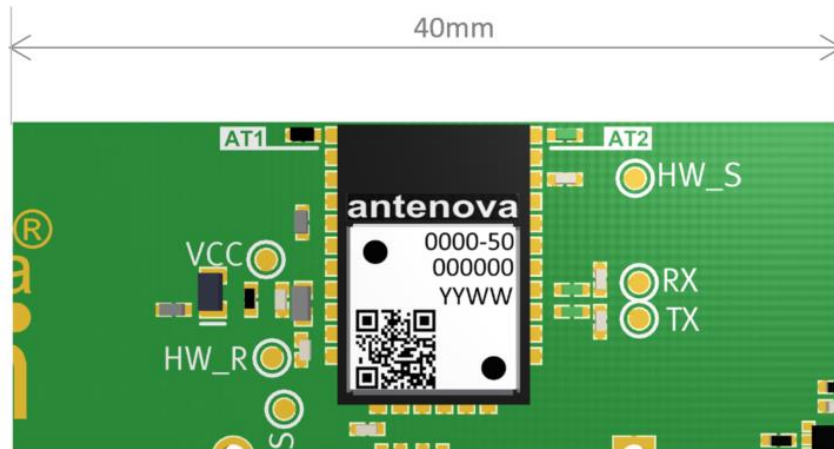

- The central placement of the module is advised. However, an offset placement is also possible.
- For an offset closer to the PCB edge to the right side of the module, a minimum of 10mm distance is required to the edge of the host PCB.

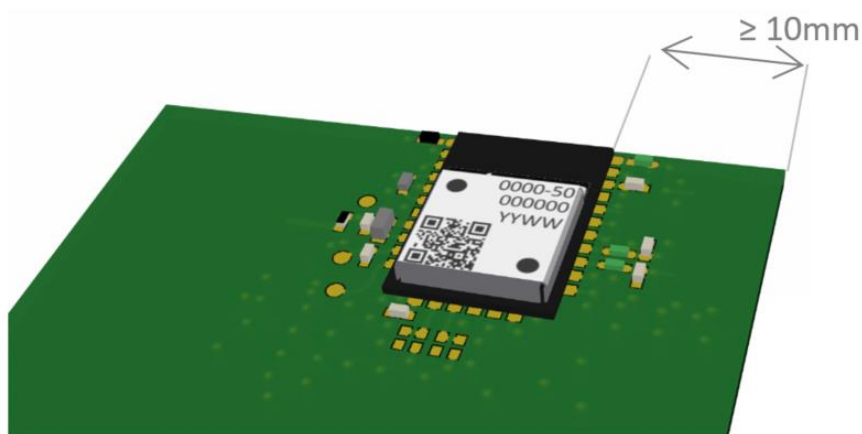

GPS RADIONOVA® RF Antenna Module

Part No. M20050-1

- The antenna uses the host PCB ground to effectively radiate. As such, a GND plane must be placed on the host PCB on at least one layer.
- In the example below, the only area void of GND is the antenna keep-out area. The solder mask is removed to make the copper visible.

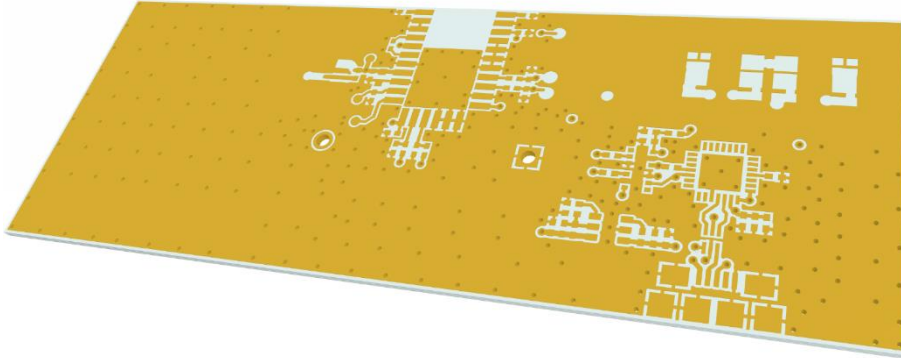

- An ideal stack-up for a host PCB would be to use the top and bottom layers as GND planes, while using the internal layers for any signal and power planes. This not only helps the GPS antenna to perform effectively, but also helps to reduce any potential noise issues that can be associated with mixed signal PCB's.
- An example below shows a 4-layer host PCB, GND flooding all available space not used by signals or components.

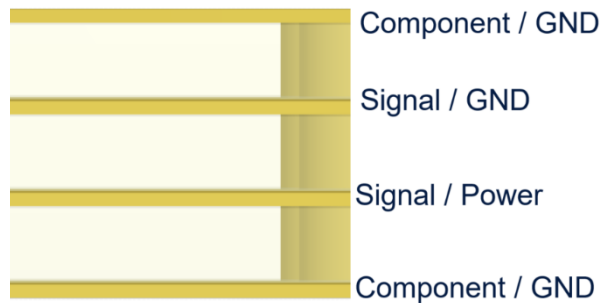

Please contact Antenova M2M for advice on placement.

Evaluation Kit

The EVK is a single PCB that contains the module and required components to run on a PC via a USB cable and Antenova software. Evaluation kits are available on request. Please contact Antenova for more information.

M20050-EVB-1

Top Side

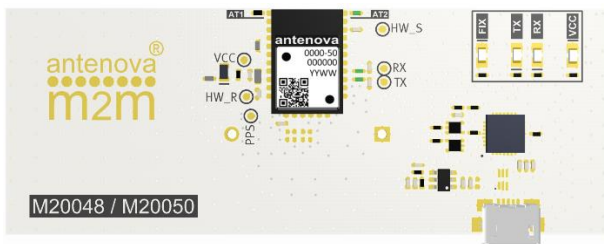

Bottom Side

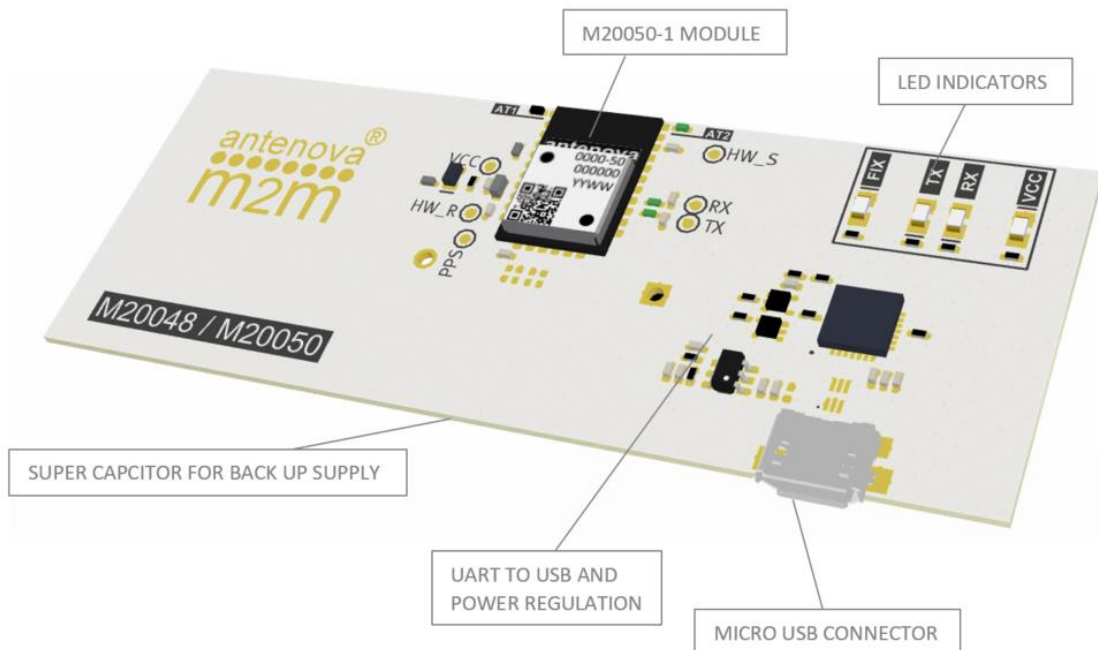
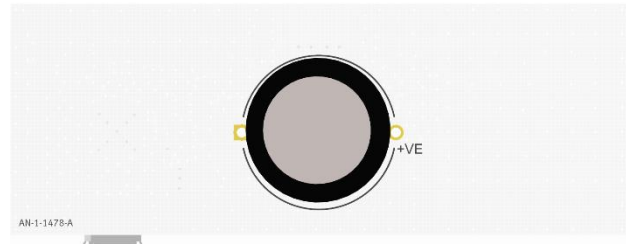

Reflow Soldering

Placement

Typical placement systems used for any BGA/LGA package are acceptable. Recommended nozzle diameter for placement: 5mm.

Soldering Paste

Use of “No Clean” soldering paste is strongly recommended, as it does not require cleaning after the soldering process has taken place. An example of suitable soldering paste is Alpha OM350.

Soldering

The recommended soldering profile for M20050-1 is shown below. However, it is the responsibility of the Contract Manufacturer to determine the exact reflow profile used, taking into consideration the parameters of the host PCB, solder paste used, etc.

Profile Feature		Pb-Free Solder
Pre-Heat	Temperature (T_s) Min	130°C
	Temperature (T_s) Max	220°C
	Time (t_s)	<150s
Reflow	Liquidus Temperature - (T_l)	220°C
	Time (t_l)	45-90s
Peak Package Body Temperature (T_p)		245°C
Time within 5°C of peak temp (t_p)		30s
Average Ramp up rate - $T_s(\text{max})$ to (T_p)		3°C/s
Ramp Down Rate		6°C/s max

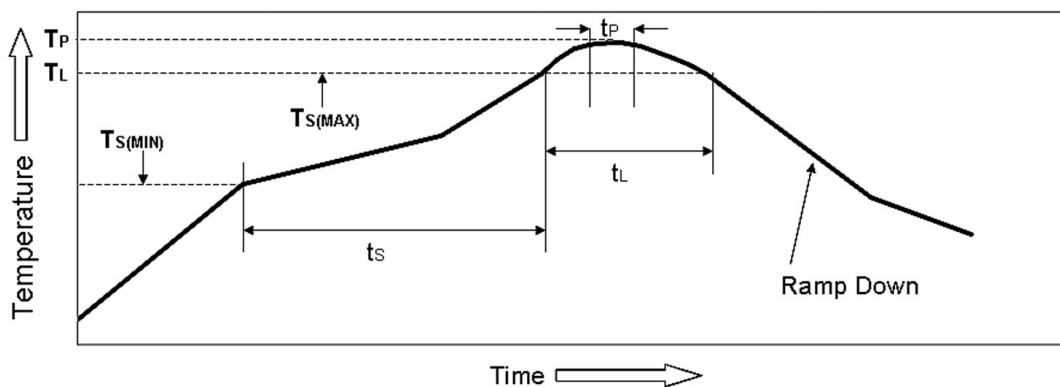

Example Reflow profile

The Pb Free Process-Package Peak Reflow Temperature is 260°C.

Exceeding the maximum soldering temperature could permanently damage the module.

Multiple Soldering

The M20050-1 module can be submitted up to 2 reflow soldering processes.

Upside-down soldering is acceptable but it is recommended that the Contract Manufacturer qualify the process before mass production. The second reflow must take place within the recommended floor life limit (MSL3). Please contact Antenova for further information.

Hand Soldering

Hand-soldering and rework of the M20050-1 module is acceptable, however care must be taken to avoid short circuits due to the small size of the module pads.

Quality and Environmental Specifications

Test	Standard	Parameters
PCB Inspection	IPC-6012B, Class 2. Qualification and Performance Specification for Rigid Printed Boards - Jan 2007	
Assembly Inspection	IPC-A-610-D, Class 2 "Acceptability of electronic assemblies"	
Temperature Range	ETSI EN 300 019-2-7 specification T 7.3	-30 °C, +25 °C, +85 °C, operating
Damp Heat	ETSI EN 300 019-2-7 specification T 7.3	+70 °C, 80% RH, 96 hrs, non-operating
Thermal Shock	ETSI EN 300 019-2-7 specification T 7.3 E	-40 °C ... +85 °C, 200 cycles
Vibration	ISO16750-3	Random vibration, 10~1000Hz, 27.8m/s ² , 8hrs/axis, X, Y, Z 8hrs for each 3 axis non-operating
Shock	ISO16750-3	Half-sinusoidal 50g, 6ms, 10time/face, ±X, ±Y and ±Z non-operating
Free Fall	ISO16750-3	1m height, 2 drops on opposite side
ESD Sensitivity	JEDEC, JESD22-A114 ESD Sensitivity Testing Human Body Model (HBM), Class 2 JEDEC, JESD22-A115 ESD Sensitivity Testing Machine Model (MM), Class B	+2000V - Human hand assembly +200V - Machine automatic final assembly
Shear	IEC 60068-2-21, Test Ue3: Shear	Force of 5N applied to the side of the PCB
Moisture/Reflow Sensitivity	IPC/JEDEC J-STD-020D.1	MSL3
Storage (Dry Pack)	IPC/JEDEC J-STD-033C	MSL3
Solderability	EN/IEC 60068-2-58 Test Td	More than 90% of the electrode should be covered by solder. Solder temperature 245 °C ± 5 °C

Moisture Sensitivity

Antenova ships all devices dry packed in tape on reel with desiccant and moisture level indicator sealed in an airtight package. If on receiving the goods the moisture indicator is pink in colour or a puncture of the airtight seal packaging is observed, then follow J-STD-033 "Handling and Use of Moisture/Reflow Sensitive Surface Mount Devices".

Storage (Out of Bag)

The M20050-1 modules meet MSL Level 3 of the JEDEC specification J-STD-020D - 168 hours Floor Life (out of bag) ≤30 °C/60% RH. If the stated floor life expires prior to reflow process then follow J-STD-033 "Handling and Use of Moisture/Reflow Sensitive Surface Mount Devices".

Hazardous material regulation conformance

The RF antenna module meets RoHS requirements.

Packaging

Tape Characteristics

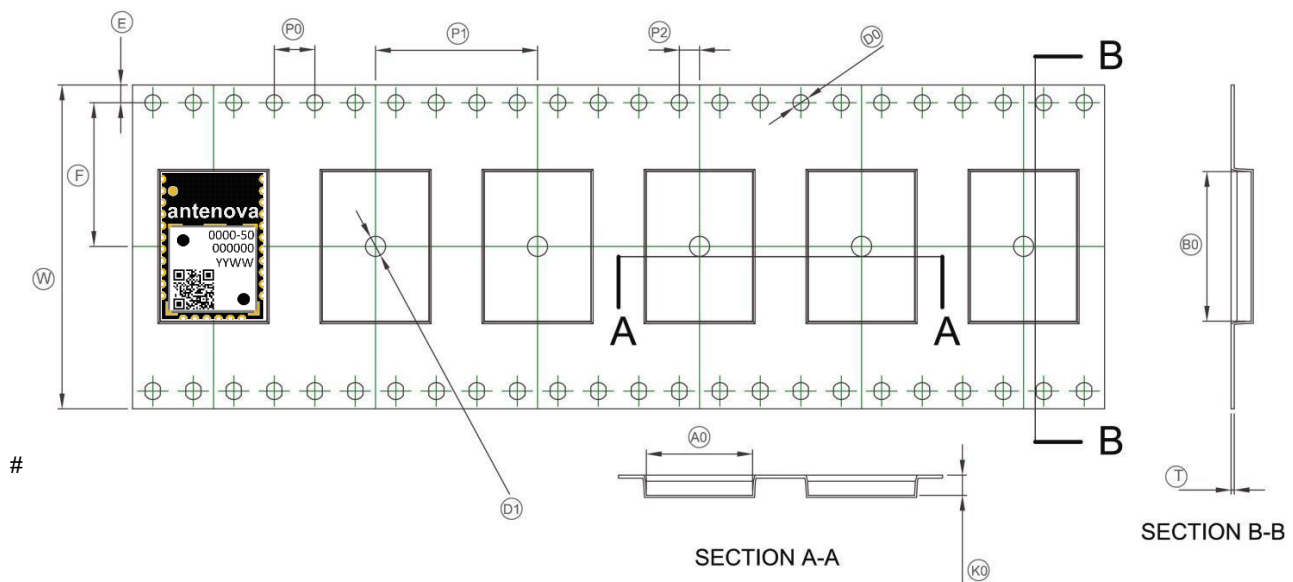

W	F	E	P0	P1	P2
32.00±0.3	14.20±0.1	1.75±0.2	4.00±0.1	16±0.1	2.00±0.1
D0	B0	T	K0	A0	D1
1.55±0.1	14.80±0.1	0.30±0.1	2.00±0.1	10.50±0.05	0.85±0.1

Dimensions in mm

Quantity	Leading Space	Trailing Space
1000 pcs / reel	50 blank module holders	50 blank module holders

Reel Dimensions

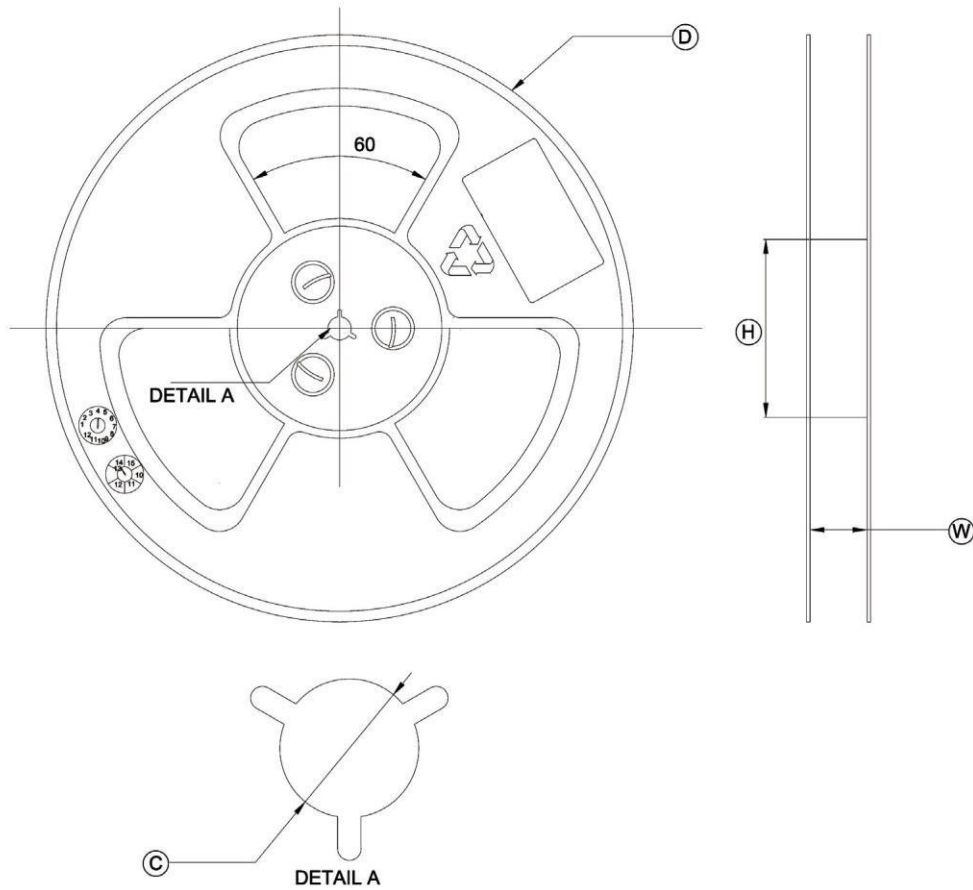

Width (W)	Reel Diameter (D)	Hub Diameter (H)	Shaft Diameter (C)
32.0mm	330.0±2mm	100.0mm	13.0+0.2/-0.0mm



www.antenova-m2m.com

Corporate Headquarters

Antenova Ltd.
2nd Floor, Titan Court,
3 Bishop Square,
Hatfield, AL10 9NA
UK

Tel: +44 (0) 1223 810600
Email: sales@antenova-m2m.com

USA Headquarters

Antenova USA
100 Brush Creek Road, Suite 103,
Santa Rosa,
CA 95404
USA

Tel: +1 (707) 890 5202
Email: sales@antenova-m2m.com

Asia Headquarters

Antenova Asia Ltd.
4F, No. 324, Sec. 1, Nei-Hu Road
Nei-Hu District
Taipei 11493
Taiwan, ROC

Tel: +886 (0) 2 8797 8630
Fax: +886 (0) 2 8797 6890
Email: sales@antenova-m2m.com

Copyright® Antenova Ltd. All Rights Reserved. Antenova®, Antenova M2M, RADIONOVA® and the Antenova and Antenova M2M logos are trademarks and/or registered trademarks of Antenova Ltd. Any other names and/or trademarks belong to their respective companies.

The materials provided herein are believed to be reliable and correct at the time of print. Antenova does not warrant the accuracy or completeness of the information, text, graphics or other items contained within these information. Antenova further assumes no responsibility for the use of this information, and all such information shall be entirely at the user's risk.



Antennas for Wireless M2M Applications

Mouser Electronics

Authorized Distributor

Click to View Pricing, Inventory, Delivery & Lifecycle Information:

[Antenova:](#)

[M20050-EVB-1](#)