

# High Frequency Ceramic Solutions

## 2450 MHz Harmonic Low Pass Filter EIA 0603, SMD

P/N 2450LP14B100

Detail Specification: 3/1/2016

Page 1 of 3

### General Specifications

Frequency (MHz)	2400 - 2500
Insertion Loss (dB)	0.50 max.
Attenuation (min.)	35 dB @ 2 x fo
Attenuation (min.)	25 dB @ 3 x fo
Power Capacity	3W max. (CW)
Recommended Storage Conditions (unmounted/unused product on T&R)	+5 ~ +35 °C, Humidity 45~75%RH
Operating Temperature	-40 to +85°C
Storage Temperature	-40 to +85°C

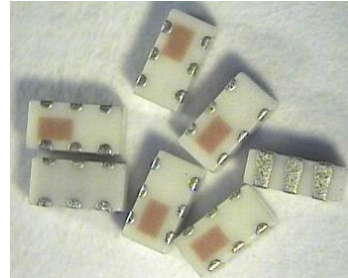

### Part Number Explanation

P/N Suffix	Packing Style	Bulk	Suffix = S	2450LP14B100S
		T & R	Suffix = T	2450LP14B100T (Reel Size: 4000pcs)
	Termination style	100% Tin	Suffix = None	2450LP14B100(T/S)
	<b>50Ω SMA Connector Eval Board</b>			<b>2450LP14B100-EB-SMA (orderable p/n)</b>

### Mechanical Dimensions

	In	mm
L	0.063 ± 0.004	1.60 ± 0.10
W	0.031 ± 0.004	0.80 ± 0.10
T	0.024 ± 0.004	0.60 ± 0.10
a	0.008 ± 0.004	0.20 ± 0.10
b	0.008 +.004/-.006	0.20 +0.1/-0.15
c	0.006 ± 0.004	0.15 ± 0.10
g	0.012 ± 0.004	0.30 ± 0.10
p	0.020 ± 0.002	0.50 ± 0.05

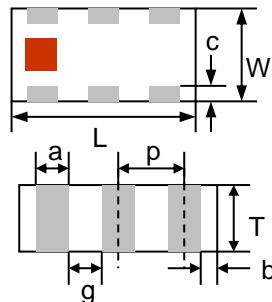



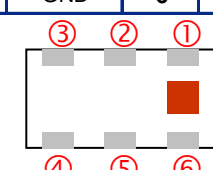

### Terminal Configuration

No.	Function	No.	Function
1	GND	4	GND
2	IN/OUT	5	IN/OUT
3	GND	6	GND

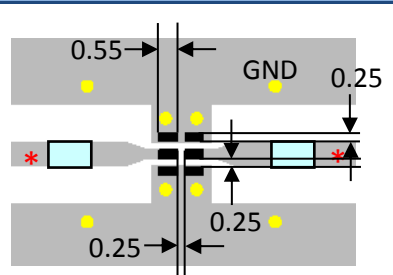

### Mounting Considerations



-  Solder Resist
-  Land
-  Through-hole ( $\phi 0.35$ )
-  If DC Blocking is required, use a 10-12pF capacitor in the I/Os

\*Trace must be designed to a 50Ω characteristic impedance based on PCB material and thickness.

Want the layout file or need us to revise your layout to make sure is correct? Send us a message at:  
[www.johansontechnology.com/ask-a-question](http://www.johansontechnology.com/ask-a-question)

Johanson Technology, Inc. reserves the right to make design changes without notice.

All sales are subject to Johanson Technology, Inc. terms and conditions.



[www.johansontechnology.com](http://www.johansontechnology.com)  
 4001 Calle Tecate • Camarillo, CA 93012 • TEL 805.389.1166 FAX 805.389.1821

Ver. 3.1

2016 Johanson Technology, Inc. All Rights Reserved

# High Frequency Ceramic Solutions

2450 MHz Harmonic Low Pass Filter EIA 0603, SMD

P/N 2450LP14B100

Detail Specification: 3/1/2016

Page 2 of 3

## Measuring Diagram

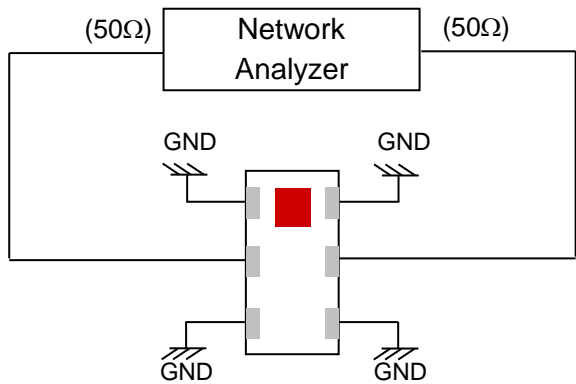

Click here Order the SMA-ready Evaluation Board p/n 2450LP14B100-EB-SMA:

[www.johansontechnology.com/request-a-sample](http://www.johansontechnology.com/request-a-sample)

## Typical Electrical Performance (T=25°C)

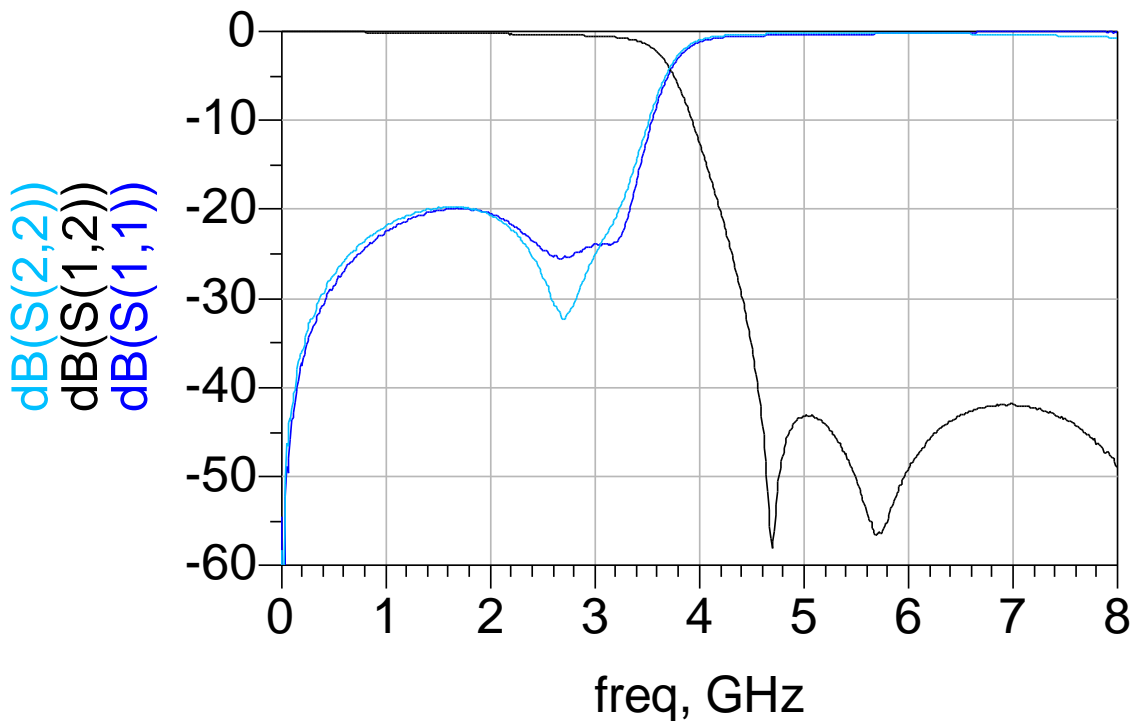

Johanson Technology, Inc. reserves the right to make design changes without notice.  
All sales are subject to Johanson Technology, Inc. terms and conditions.



# High Frequency Ceramic Solutions

**2450 MHz Harmonic Low Pass Filter EIA 0603, SMD**

**P/N 2450LP14B100**

Detail Specification: 3/1/2016

Page 3 of 3

## Packaging information

[www.johansontechnology.com/tape-reel-packaging](http://www.johansontechnology.com/tape-reel-packaging)

## Soldering Information

[www.johansontechnology.com/typical-soldering-profile.html](http://www.johansontechnology.com/typical-soldering-profile.html)

## RoHS Compliance

[www.johansontechnology.com/rohs-compliance](http://www.johansontechnology.com/rohs-compliance)

## MSL Info

[www.johansontechnology.com/msl-rating](http://www.johansontechnology.com/msl-rating)

## To Download Measured S-parameters for Evaluation and Simulation:

[www.johansontechnology.com/low-pass-filters](http://www.johansontechnology.com/low-pass-filters)

## For layout review contact our Applications Team at:

[www.johansontechnology.com/ask-a-question](http://www.johansontechnology.com/ask-a-question)

Johanson Technology, Inc. reserves the right to make design changes without notice.  
All sales are subject to Johanson Technology, Inc. terms and conditions.



[www.johansontechnology.com](http://www.johansontechnology.com)  
4001 Calle Tecate • Camarillo, CA 93012 • TEL 805.389.1166 FAX 805.389.1821  
Ver. 3.1 2016 Johanson Technology, Inc. All Rights Reserved

# Mouser Electronics

Authorized Distributor

Click to View Pricing, Inventory, Delivery & Lifecycle Information:

[Johanson:](#)

[2450LP14B100T](#)